



UNIVERSITY OF THE PHILIPPINES VISAYAS
Bids and Awards Committee
Miagao, Iloilo

RENOVATION OF HEALTH SERVICES UNIT (ITB-2024-008)

Pre-Bid Conference	Submission / Opening of Bids
05 April 2024, 9:00AM	19 April 2024, 9:00AM
CM12, College of Management Bldg., UP Visayas, Iloilo City	CM12, College of Management Bldg., UP Visayas, Iloilo City
Site Inspection: To be discussed during pre-bidding conference.	



**UNIVERSITY OF THE PHILIPPINES VISAYAS
BIDS AND AWARDS COMMITTEE
Iloilo City**

**INVITATION TO BID / REQUEST FOR EXPRESSION OF INTEREST
2024-008**

The UNIVERSITY OF THE PHILIPPINES VISAYAS, through its Bids and Awards Committee (BAC), invites qualified Suppliers/Contractors to bid for the project: **“RENOVATION OF HEALTH SERVICES UNIT (ITB-2024-008).**

Total ABC	Location	Pre-Bid Conference	Submission / Opening of Bids	Contract Duration	Bidding Fee
Php 1,994,364.67	UPV Miagao Campus	05 April 2024, 9:00AM CM12, College of Management Bldg., UP Visayas, Iloilo City With Zoom link Site Inspection: To be discussed during pre-bidding conference.	19 April 2024, 9:00AM CM12, College of Management Bldg., UP Visayas, Iloilo City With Zoom link	63 Calendar Days	P2,000.00
		Zoom Meeting ID: 879 737 7116	Passcode: upvbac2022		

Prospective Bidders should possess a valid **PCAB License Category D or higher**, have completed a similar contract with a value of at least 50% of the ABC and have the key personnel and equipment listed in the eligibility forms available for execution of the contract.

The BAC will use non-discretionary pass/fail criteria in the Eligibility Check/Screening as well as the Preliminary Examination of Bids and will conduct post-qualification of the lowest calculated and responsive bid. All particulars relative to Eligibility Statement and Screening, Bid Security, Performance Security, Evaluation of Bids, Post- Qualification and Award of Contract shall be governed by the pertinent provisions of RA 9184 and its Implementing Rules and Regulations (IRR), as amended.

A complete set of Bidding Documents may be acquired by interested bidders starting **27 March 2024, 8:30 – 4:00 p.m., Bids and Awards Committee Secretariat Office, SPSO UPV, Iloilo City Campus** and upon payment of a non-refundable fee for the Bidding Documents, in the amount stated above.

Request for clarification/s on any part of the bidding documents or for an interpretation must be in writing and submitted to the BAC Secretariat at least ten (10) days before the deadline set for the submission and receipt of bids.

Late Bids shall not be accepted.

The **University of the Philippines Visayas (UPV)** reserves the right to reject any or all bids, declare a failure of bidding, without offering any reason, waive any defect therein and make an award to the bidder whose proposal is most advantageous to the University. The University assumes no obligation for whatever losses that may be incurred by the bidders in the preparation of the bids nor does it guarantee that the award shall be made.

Inquiries may be forwarded to:

EMILIZA C. LOZADA
Head, Bids and Awards Committee Secretariat
SPSO, Administrative Services Building, UP Visayas, Iloilo City
Telefax No. (033) 315-9858; (033) 315-81-41
(033) 315-9632 loc. 180 / 247
CP # 09171475733 (Iloilo City Office)
E-mail: upvbac@yahoo.com bac@upv.edu.ph

Bidding Fee:

UPV Bank details:

**UPV Account No: 3052-101-513
Account Name: UP VISAYAS
Land Bank of the Phils.
Miag-ao Branch**

Deposit slips must be e-mailed to: bac@upv.edu.ph

For bidders outside of Iloilo, Bidding documents may be sent thru courier addressed to:

MS. ARLENE AVANCEÑA
Chair
UPV Bids and Awards Committee
SPSO, Administrative Services Building, U.P. Visayas, Iloilo City
CP #09171475733

together with an authorization letter outside the sealed envelope authorizing the bids and awards committee to open your bid during the opening of bids. It is the responsibility of the bidder to ensure that the Bidding documents are received by the BAC Secretariat before the deadline.

Request for clarification/s on any part of the bidding documents or for an interpretation must be in writing and submitted to the BAC Secretariat at least Ten (10) calendar days before the deadline set for the submission and receipt of bids.

Late Bids shall not be accepted

The **University of the Philippines Visayas (UPV)** reserves the right to reject any or all bids, declare a failure of bidding, without offering any reason, waive any defect therein and make and award to the bidder whose proposal is most advantageous to the University. The University likewise, assumes no obligation for whatever losses that may incurred by the bidders in the preparation of the bids nor does it guarantee that the award shall be made.

Inquiries may be forwarded to:

EMILIZA C. LOZADA
Bids and Awards Committee Secretariat
Supply and Property Services Office
UP Visayas, Iloilo City
Telefax No. (033) 315-9858; (033) 315-81-41
(033) 315-9632 loc. 180 / 247
(033) 336-55-64 (Iloilo City Office)
E-mail: upvbac@yahoo.com / bac@upv.edu.ph
CP No. 09171475733

MS. ARLENE N. AVACEÑA
Chair, Bids and Awards Committee

Date of Posting: _____

Section II. Instructions to Bidders

Notes on the Instructions to Bidders

This section of the Bidding Documents provides the information necessary for Bidders to prepare responsive bids, in accordance with the requirements of the Procuring Entity. It also provides information on the eligibility check, bid submission, opening, evaluation, and on the award of contract.

This section contains provisions that are to be used unchanged. Section III consists of provisions that supplement, amend, or specify in detail, information or requirements included in this section which are specific to each procurement.

Matters governing performance of the Contractor, payments under the contract, or matters affecting the risks, rights, and obligations of the parties under the contract are not normally included in this section, but rather under the General Conditions of Contract (GCC), and/or Special Conditions of Contract (SCC). If duplication of a subject is inevitable in the other sections of the document prepared by the Procuring Entity, care must be exercised to avoid contradictions between clauses dealing with the same matter.

A. General

1. Scope of Bid

- 1.1 The Procuring Entity as defined in the BDS, invites bids for the construction of Works, as described in Section IV. The name and identification number of the Contract is provided in the BDS.
- 1.2 The successful bidder will be expected to complete the Works by the intended completion date specified in SCC **Clause1.16**.

2. Source of Funds

The Procuring Entity has a budget or has applied for or received funds from the Funding Source named in the BDS, and in the amount indicated in the BDS. It intends to apply part of the funds received for the Project, as defined in the BDS, to cover eligible payments under the Contract for the Works.

3. Corrupt, Fraudulent, Collusive, and Coercive Practices

- 3.1 Unless otherwise specified in the BDS, the Procuring Entity, as well as bidders and contractors, shall observe the highest standard of ethics during the procurement and execution of the contract. In pursuance of this policy, the Procuring Entity:
 - (a) defines, for purposes of this provision, the terms set forth below as follows:
 - (i) "corrupt practice" means behavior on the part of officials in the public or private sectors by which they improperly and unlawfully enrich themselves, others, or induce others to do so, by misusing the position in which they are placed, and includes the offering, giving, receiving, or soliciting of anything of value to influence the action of any such official in the procurement process or in contract execution; entering, on behalf of the Procuring Entity, into any contract or transaction manifestly and grossly disadvantageous to the same, whether or not the public officer profited or will profit thereby, and similar acts as provided in Republic Act 3019;
 - (ii) "fraudulent practice" means a misrepresentation of facts in order to influence a procurement process or the execution of a contract to the detriment of the Procuring Entity, and includes collusive practices among Bidders (prior to or after Bid submission) designed to establish bid prices at artificial, non-competitive levels and to deprive the Procuring Entity of the benefits of free and open competition;
 - (iii) "collusive practices" means a scheme or arrangement between two or more bidders, with or without the knowledge of the Procuring Entity, designed to establish bid prices at artificial, non-competitive levels; and
 - (iv) "coercive practices" means harming or threatening to harm, directly or indirectly, persons, or their property to influence their participation in a procurement process, or affect the execution of a contract;
 - (v) "obstructive practice" is
 - (aa) deliberately destroying, falsifying, altering or concealing of evidence material to an administrative proceedings or investigation or making false statements to investigators in order to materially impede an administrative proceedings or investigation of the Procuring Entity or any foreign

government/foreign or international financing institution into allegations of a corrupt, fraudulent, coercive or collusive practice; and/or threatening, harassing or intimidating any party to prevent it from disclosing its knowledge of matters relevant to the administrative proceedings or investigation or from pursuing such proceedings or investigation; or

- (bb) acts intended to materially impede the exercise of the inspection and audit rights of the Procuring Entity or any foreign government/foreign or international financing institution herein.
 - (b) will reject a proposal for award if it determines that the bidder recommended for award has engaged in corrupt or fraudulent practices in competing for the Contract; and
 - (c) will declare a firm ineligible, either indefinitely or for a stated period of time, to be awarded Contract funded by the Funding Source if it at any time determines that the firm has engaged in corrupt or fraudulent practices in competing or, or in executing, a Contract funded by the Funding Source.
- 3.2 Further, the Procuring Entity will seek to impose the maximum civil, administrative, and/or criminal penalties available under the applicable laws on individuals and organizations deemed to be involved in any of the practices mentioned in **ITB** Clause 3.1(a).
- 3.3 Furthermore, the Funding Source and the Procuring Entity reserve the right to inspect and audit records and accounts of a contractor in the bidding for and performance of a contract themselves or through independent auditors as reflected in the **GCC** Clause 34.

4. Conflict of Interest

- 4.1 All bidders found to have conflicting interests shall be disqualified to participate in the procurement at hand, without prejudice to the imposition of appropriate administrative, civil, and criminal sanctions. A Bidder may be considered to have conflicting interests with another Bidder in any of the events described in paragraphs (a) through (c) and a general conflict of interest in any of the circumstances set out in paragraphs (d) through (g) below:
- (a) A Bidder has controlling shareholders in common with another Bidder;
 - (b) A Bidder receives or has received any direct or indirect subsidy from any other Bidder;
 - (c) A Bidder has the same legal representative as that of another Bidder for purposes of this Bid;
 - (d) A Bidder has a relationship, directly or through third parties, that puts them in a position to have access to information about or influence on the bid of another Bidder or influence the decisions of the Procuring Entity regarding this bidding process. This will include a firm or an organization who lends, or temporarily seconds, its personnel to firms or organizations which are engaged in consulting services for the preparation related to procurement for or implementation of the project if the personnel would be involved in any capacity on the same project;
 - (e) A Bidder submits more than one bid in this bidding process. However, this does not limit the participation of subcontractors in more than one bid;

- (f) A Bidder who participated as a consultant in the preparation of the design or technical specifications of the goods and related services that are the subject of the bid; or
- (g) A Bidder who lends, or temporary seconds, its personnel to firms or organizations which are engaged in consulting services for the preparation related to procurement for or implementation of the project, if the personnel would be involved in any capacity on the same project.

4.2 In accordance with Section 47 of the IRR of RA 9184, all Bidding Documents shall be accompanied by a sworn affidavit of the Bidder that it is not related to the Head of the Procuring Entity, members of the Bids and Awards Committee (BAC), members of the Technical Working Group (TWG), members of the BAC Secretariat, the head of the Project Management Office (PMO) or the end-user unit, and the project consultants, by consanguinity or affinity up to the third civil degree. On the part of the bidder, this Clause shall apply to the following persons:

- (a) If the Bidder is an individual or a sole proprietorship, to the Bidder himself;
- (b) If the Bidder is a partnership, to all its officers and members;
- (c) If the Bidder is a corporation, to all its officers, directors, and controlling stockholders; and
- (d) If the Bidder is a joint venture (JV), the provisions of items (a), (b), or (c) of this Clause shall correspondingly apply to each of the members of the said JV, as may be appropriate.

Relationship of the nature described above or failure to comply with this Clause will result in the automatic disqualification of a Bidder.

5. Eligible Bidders

5.1 Unless otherwise indicated in the BDS, the following persons shall be eligible to participate in this Bidding:

- (a) Duly licensed Filipino citizens/sole proprietorships;
- (b) Partnerships duly organized under the laws of the Philippines and of which at least seventy five percent (75%) of the interest belongs to citizens of the Philippines;
- (c) Corporations duly organized under the laws of the Philippines, and of which at least seventy five percent (75%) of the outstanding capital stock belongs to citizens of the Philippines;
- (d) Cooperatives duly organized under the laws of the Philippines, and of which at least seventy five percent (75%) of the interest belongs to citizens of the Philippines; and
- (e) Persons/entities forming themselves into a JV, i.e., a group of two (2) or more persons/entities that intend to be jointly and severally responsible or liable for a particular contract: Provided, however, that, in accordance with Letter of Instructions No. 630, Filipino ownership or interest of the joint venture concerned shall be at least seventy five percent (75%): Provided, further, that joint ventures in which Filipino ownership or interest is less than seventy five percent (75%) may be eligible where the structures to be built require the application of techniques and/or technologies which are not adequately possessed by a person/entity meeting the seventy five percent (75%) Filipino ownership requirement: Provided, finally, that in the latter case, Filipino ownership or interest shall not be less than twenty five percent (25%). For this

purpose Filipino ownership or interest shall be based on the contributions of each of the members of the joint venture as specified in their JVA.

- 5.2 The Procuring Entity may also invite foreign bidders when provided for under any Treaty or International or Executive Agreement as specified in the BDS.
- 5.3 Government Corporate Entities may be eligible to participate only if they can establish that they (a) are legally and financially autonomous, (b) operate under commercial law, and (c) are not dependent agencies of the GOP or the Procuring Entity.
- 5.4 (a) Unless otherwise provided in the BDS, the Bidder must have an experience of having completed at least one (1) contract that is similar to this Project, equivalent to at least fifty per cent (50%) of the ABC adjusted to current prices using the National Statistic Office consumer price index. However, contractors under Small A and Small B categories without similar experience on the contract to be bid may be allowed to bid if the cost of such contract is not more than fifty percent (50%) of the Allowable Range of the Contract Cost (ARCC) of their registration based on the guidelines as prescribed by the PCAB.
- (b) For Foreign-funded Procurement, the Procuring Entity and the foreign government/foreign or international financing institution may agree on another track record requirement, as specified in the BDS.

For this purpose, contracts similar to the Project shall be those described in the BDS, and completed within the period stated in the Invitation to Bid and **ITB** Clause 12.1(a)(iii)

- 5.5 The Bidder must submit a computation of its Net Financial Contracting Capacity (NFCC), which must be at least equal to the ABC to be bid, calculated as follows:

$$\text{NFCC} = [(\text{Current assets minus current liabilities}) (K)] \text{ minus the value of all outstanding or uncompleted portions of the projects under ongoing contracts, including awarded contracts yet to be started coinciding with the contract to be bid.}$$

Where:

K = 10 for a contract duration of one year or less, 15 for a contract duration of more than one year up to two years, and 20 for a contract duration of more than two years.

The values of the bidder's current assets and current liabilities shall be based on the data submitted to the BIR, through its Electronic Filing and Payment System (EFPS).

6. Bidder's Responsibilities

- 6.1 The Bidder or its duly authorized representative shall submit a sworn statement in the form prescribed in Section IX as required in **ITB** Clause 12.1(b)(iii).
- 6.2 The Bidder is responsible for the following:
- (a) Having taken steps to carefully examine all of the Bidding Documents;
 - (b) Having acknowledged all conditions, local or otherwise, affecting the implementation of the contract;
 - (c) Having made an estimate of the facilities available and needed for the contract to be bid, if any;
 - (d) Having complied with its responsibility to inquire or secure Supplemental/Bid Bulletin/s as provided under **ITB** Clause 10.3.

- (e) Ensuring that it is not “blacklisted” or barred from bidding by the GOP or any of its agencies, offices, corporations, or LGUs, including foreign government/foreign or international financing institution whose blacklisting rules have been recognized by the GPPB;
- (f) Ensuring that each of the documents submitted in satisfaction of the bidding requirements is an authentic copy of the original, complete, and all statements and information provided therein are true and correct;
- (g) Authorizing the Head of the Procuring Entity or its duly authorized representative/s to verify all the documents submitted;
- (h) Ensuring that the signatory is the duly authorized representative of the Bidder, and granted full power and authority to do, execute and perform any and all acts necessary and/or to represent the Bidder in the bidding, with the duly notarized Secretary’s Certificate attesting to such fact, if the Bidder is a corporation, partnership, cooperative, or joint venture;
- (i) Complying with the disclosure provision under Section 47 of the Act in relation to other provisions of Republic Act 3019; and
- (i) Complying with existing labor laws and standards, if applicable.

Failure to observe any of the above responsibilities shall be at the risk of the Bidder concerned.

- 6.3 The Bidder, by the act of submitting its bid, shall be deemed to have inspected the site, determined the general characteristics of the contract works and the conditions for this Project and examine all instructions, forms, terms, and project requirements in the Bidding Documents.
- 6.4 It shall be the sole responsibility of the prospective bidder to determine and to satisfy itself by such means as it considers necessary or desirable as to all matters pertaining to this Project, including: (a) the location and the nature of the contract, project, or work; (b) climatic conditions; (c) transportation facilities; (c) nature and condition of the terrain, geological conditions at the site communication facilities, requirements, location and availability of construction aggregates and other materials, labor, water, electric power and access roads; and (d) other factors that may affect the cost, duration and execution or implementation of the contract, project, or work.
- 6.5 The Procuring Entity shall not assume any responsibility regarding erroneous interpretations or conclusions by the prospective or eligible bidder out of the data furnished by the procuring entity.
- 6.6 Before submitting their bids, the Bidders are deemed to have become familiar with all existing laws, decrees, ordinances, acts and regulations of the Philippines which may affect the contract in any way.
- 6.7 The Bidder shall bear all costs associated with the preparation and submission of his bid, and the Procuring Entity will in no case be responsible or liable for those costs, regardless of the conduct or outcome of the bidding process.
- 6.8 Bidders should note that the Procuring Entity will only accept bids only from those that have paid the nonrefundable fee for the Bidding Documents at the office indicated in the Invitation to Bid.

7. Origin of GOODS and Services

There is no restriction on the origin of Goods, or Contracting of Works or Services other than those prohibited by a decision of the United Nations Security Council taken under Chapter VII of the Charter of the United Nations.

8. Subcontracts

- 8.1 Unless otherwise specified in the BDS, the Bidder may subcontract portions of the Works to an extent as may be approved by the Procuring Entity and stated in the BDS. However, subcontracting of any portion shall not relieve the Bidder from any liability or obligation that may arise from the contract for this Project.
- 8.2 Subcontractors must submit the documentary requirements under **ITB** Clause 12 and comply with the eligibility criteria specified in the BDS. In the event that any subcontractor is found by the Procuring Entity to be ineligible, the subcontracting of such portion of the Works shall be disallowed.
- 8.3 The Bidder may identify the subcontractor to whom a portion of the Works will be subcontracted at any stage of the bidding process or during contract implementation. If the Bidder opts to disclose the name of the subcontractor during bid submission, the Bidder shall include the required documents as part of the technical component of its bid.

B. Contents of Bidding Documents

9. Pre-Bid Conference

- 9.1 (a) If so specified in the BDS, a pre-bid conference shall be held at the venue and on the date indicated therein, to clarify and address the Bidders' questions on the technical and financial components of this Project.

(b) The pre-bid conference shall be held at least twelve (12) calendar days before the deadline for the submission of and receipt of bids. If the Procuring Entity determines that, by reason of the method, nature, or complexity of the contract to be bid, or when international participation will be more advantageous to the GOP, a longer period for the preparation of bids is necessary, the pre-bid conference shall be held at least thirty (30) calendar days before the deadline for the submission and receipt of bids, as specified in the BDS.
- 9.2 Bidders are encouraged to attend the pre-bid conference to ensure that they fully understand the Procuring Entity's requirements. Non-attendance of the Bidder will in no way prejudice its bid; however, the Bidder is expected to know the changes and/or amendments to the Bidding Documents as recorded in the minutes of the pre-bid conference and the Supplemental/Bid Bulletin.
- 9.3 Any statement made at the pre-bid conference shall not modify the terms of the bidding documents unless such statement is specifically identified in writing as an amendment thereto and issued as a Supplemental/Bid Bulletin.

10. Clarification and Amendment of Bidding Documents

- 10.1 Bidders who have purchased the Bidding Documents may request for clarification(s) on any part of the Bidding Documents or for an interpretation. Such a request must be in writing and submitted to the Procuring Entity at the address indicated in the BDS at least ten (10) calendar days before the deadline set for the submission and receipt of Bids.
- 10.2 Supplemental/Bid Bulletins may be issued upon the Procuring Entity's initiative for purposes of clarifying or modifying any provision of the Bidding Documents not later than seven (7) calendar days before the deadline for the submission and receipt of Bids. Any modification to the Bidding Documents shall be identified as an amendment.
- 10.3 Any Supplemental/Bid Bulletin issued by the BAC shall also be posted on the Philippine Government Electronic Procurement System (PhilGEPS) and the website of the Procuring Entity concerned, if available. Unless, otherwise provided in the BDS, it shall

be the responsibility of all Bidders who secure the Bidding Documents to inquire and secure Supplemental/Bid Bulletins that may be issued by the BAC. However, bidders who have submitted bids before the issuance of the Supplemental/Bid Bulletin must be informed and allowed to modify or withdraw their bids in accordance with **ITB Clause 23**.

C. Preparation of Bids

11. Language of Bids

The Bid, as well as all correspondence and documents relating to the Bid exchanged by the Bidder and the Procuring Entity, shall be written in English. Supporting documents and printed literature furnished by the Bidder may be in another language provided they are accompanied by an accurate translation in English certified by the appropriate embassy or consulate in the Philippines, in which case the English translation shall govern, for purposes of interpretation of the Bid.

12. Documents Comprising the Bid: Eligibility and Technical Components

12.1 Unless otherwise indicated in the **BDS**, the first envelope shall contain the following eligibility and technical documents:

(a) Eligibility Documents –

Class "A" Documents:

- (i) Registration certificate from the Securities and Exchange Commission (SEC), Department of Trade and Industry (DTI) for sole proprietorship, or Cooperative Development Authority (CDA) for cooperatives, or any proof of such registration as stated in the **BDS**;
- (ii) Mayor's permit issued by the city or municipality where the principal place of business of the prospective bidder is located;
- (iii) Statement of all its ongoing and completed government and private contracts within ten (10) years from the submission of bids, including contracts awarded but not yet started, if any. The statement shall include, for each contract, the following:
 - (iii.1) name of the contract;
 - (iii.2) date of the contract;
 - (iii.3) contract duration;
 - (iii.4) owner's name and address;
 - (iii.5) nature of work;
 - (iii.6) contractor's role (whether sole contractor, subcontractor, or partner in a JV) and percentage of participation;
 - (iii.7) total contract value at award;
 - (iii.8) date of completion or estimated completion time;
 - (iii.9) total contract value at completion, if applicable;
 - (iii.10) percentages of planned and actual accomplishments, if applicable;

- (iii.11) value of outstanding works, if applicable;
- (iii.12) the statement shall be supported by the notices of award and/or notices to proceed issued by the owners; and
- (iii.13) the statement shall be supported by the Owner's Certificate of Final Acceptance or the Certificate of Completion and, whenever applicable, the Constructor's Performance Evaluation Summary (CPES) Final Rating, which must be satisfactory.
- (iv) Unless otherwise provided in the BDS, valid Philippine Contractors Accreditation Board (PCAB) license and registration for the type and cost of the contract for this Project;
- (v) Audited financial statements, showing, among others, the prospective total and current assets and liabilities, stamped "received" by the BIR or its duly accredited and authorized institutions, for the preceding calendar year which should not be earlier than two (2) years from the date of bid submission;
- (vi) NFCC computation in accordance with ITB Clause 5.5
- (vii) Tax Clearance Certificate

Class "B" Document:

- (viii) If applicable, valid Joint Venture Agreement (JVA) or, in lieu thereof, duly notarized statements from all the potential joint venture partners stating that they will enter into and abide by the provisions of the JVA in the instance that the bid is successful shall be included in the bid.
- (b) Technical Documents –
 - (i) Bid security as prescribed in **ITB** Clause 18. If the Bidder opts to submit the bid security in the form of:
 - (i.1) a bank draft/guarantee or an irrevocable letter of credit issued by a foreign bank, it shall be accompanied by a confirmation from a Universal or Commercial Bank; or
 - (i.2) a surety bond accompanied by a certification coming from an authorized Insurance Commission that a surety or insurance company is authorized to issue such instrument;
 - (ii) Project Requirements, which shall include the following:
 - (ii.1) Organizational chart for the contract to be bid;
 - (ii.2) List of contractor's personnel (*viz*, project Manager, Project Engineers, Materials Engineers, and Foremen), to be assigned to the contract to be bid, with their complete qualification and experience data; and
 - (ii.3) List of contractor's equipment units, which are owned, leased, and/or under purchase agreements, supported by certification of availability of equipment from the equipment lessor/vendor for the duration of the project; and
 - (iii) Sworn statement in accordance with Section 25.2(b)(iv) of the IRR of RA 9184 and using the form prescribed in Section IX.

13. Documents Comprising the Bid: Financial Component

- 13.1 Unless otherwise stated in the BDS, the financial component of the bid shall contain the following:
- (a) Financial Bid Form in accordance with the form prescribed in Section IX; and
 - (b) Any other document related to the financial component of the bid as stated in the BDS.
- 13.2 (a) Unless indicated in the BDS, all Bids that exceed the ABC shall not be accepted.
- (b) Unless otherwise indicated in the BDS, for foreign-funded procurement, a ceiling may be applied to bid prices provided the following conditions are met:
- (i) Bidding Documents are obtainable free of charge on a freely accessible website. If payment of Bidding Documents is required by the procuring entity, payment could be made upon the submission of bids.
 - (ii) The procuring entity has procedures in place to ensure that the ABC is based on recent estimates made by the engineer or the responsible unit of the procuring entity and that the estimates are based on adequate detailed engineering (in the case of works) and reflect the quality, supervision and risk and inflationary factors, as well as prevailing market prices, associated with the types of works or goods to be procured.
 - (iii) The procuring entity has trained cost estimators on estimating prices and analyzing bid variances. In the case of infrastructure projects, the procuring entity must also have trained quantity surveyors.
 - (iv) The procuring entity has established a system to monitor and report bid prices relative to ABC and engineer's/procuring entity's estimate.
 - (v) The procuring entity has established a monitoring and evaluation system for contract implementation to provide a feedback on actual total costs of goods and works.

14. Alternative Bids

- 14.1 Alternative Bids shall be rejected. For this purpose, alternative bid is an offer made by a Bidder in addition or as a substitute to its original bid which may be included as part of its original bid or submitted separately therewith for purposes of bidding. A bid with options is considered an alternative bid regardless of whether said bid proposal is contained in a single envelope or submitted in two (2) or more separate bid envelopes.
- 14.2 Bidders shall submit offers that comply with the requirements of the Bidding Documents, including the basic technical design as indicated in the drawings and specifications. Unless there is a value engineering clause in the BDS, alternative bids shall not be accepted.
- 14.3 Each Bidder shall submit only one Bid, either individually or as a partner in a JV. A Bidder who submits or participates in more than one bid (other than as a subcontractor if a subcontractor is permitted to participate in more than one bid) will cause all the proposals with the Bidder's participation to be disqualified. This shall be without prejudice to any applicable criminal, civil and administrative penalties that may be imposed upon the persons and entities concerned.

15. Bid Prices

- 15.1 The contract shall be for the whole Works, as described in **ITB** Clause 1.1, based on the priced Bill of Quantities submitted by the Bidder.
- 15.2 The Bidder shall fill in rates and prices for all items of the Works described in the Bill of Quantities. Bids not addressing or providing all of the required items in the Bidding Documents including, where applicable, bill of quantities, shall be considered non-responsive and, thus, automatically disqualified. In this regard, where a required item is provided, but no price is indicated, the same shall be considered as non-responsive, but specifying a "0" (zero) for the said item would mean that it is being offered for free to the Government.
- 15.3 All duties, taxes, and other levies payable by the Contractor under the Contract, or for any other cause, prior to the deadline for submission of bids, shall be included in the rates, prices, and total bid price submitted by the Bidder.
- 15.4 All bid prices for the given scope of work in the contract as awarded shall be considered as fixed prices, and therefore not subject to price escalation during contract implementation, except under extraordinary circumstances as specified in GCC Clause 48. Price escalation may be allowed in extraordinary circumstances as may be determined by the National Economic and Development Authority in accordance with the Civil Code of the Philippines, and upon the recommendation of the Procuring Entity. Furthermore, in cases where the cost of the awarded contract is affected by any applicable new laws, ordinances, regulations, or other acts of the GOP, promulgated after the date of bid opening, a contract price adjustment shall be made or appropriate relief shall be applied on a no loss-no gain basis.

16. Bid Currencies

- 16.1 All bid prices shall be quoted in Philippine Pesos unless otherwise provided in the BDS. However, for purposes of bid evaluation, bids denominated in foreign currencies shall be converted to Philippine currency based on the exchange rate prevailing on the day of the Bid opening.
- 16.2 If so allowed in accordance with **ITB** Clause 16.1, the Procuring Entity for purposes of bid evaluation and comparing the bid prices will convert the amounts in various currencies in which the bid price is expressed to Philippine Pesos at the exchange rate as published in the BSP reference rate bulletin on the day of the bid opening.
- 16.3 Unless otherwise specified in the BDS, payment of the contract price shall be made in Philippine Pesos.

17. Bid Validity

- 17.1 Bids shall remain valid for the period specified in the BDS which shall not exceed one hundred twenty (120) calendar days from the date of the opening of bids.
- 17.2 In exceptional circumstances, prior to the expiration of the bid validity period, the Procuring Entity may request Bidders to extend the period of validity of their bids. The request and the responses shall be made in writing. The bid security described in **ITB** Clause 18 should also be extended corresponding to the extension of the bid validity period at the least. A Bidder may refuse the request without forfeiting its bid security, but his bid shall no longer be considered for further evaluation and award. A Bidder granting the request shall not be required or permitted to modify its bid.

18 Bid Security

- 18.1 The bid security in the amount stated in the BDS shall be equal to the percentage of the ABC in accordance with the following schedule:

Form of Bid Security	Amount of Bid Security (Equal to Percentage of the ABC)
(a) Cash or cashier's/manager's check issued by a Universal or Commercial Bank.	Two percent (2%)
(b) Bank draft/guarantee or irrevocable letter of credit issued by a Universal or Commercial Bank: Provided, however, that it shall be confirmed or authenticated by a Universal or Commercial Bank, if issued by a foreign bank.	
(c) Surety bond callable upon demand issued by a surety or insurance company duly certified by the Insurance Commission as authorized to issue such security; and/or	Five percent (5%)
(d) Any combination of the foregoing.	Proportionate to share of form with respect to total amount of security
(e) Bid Securing Declaration	No percentage required

For biddings conducted by local government units, the Bidder may also submit bid securities in the form of cashier's/manager's check, bank draft/guarantee, or irrevocable letter of credit from other banks certified by the BSP as authorized to issue such financial statement.

The Bid Securing Declaration mentioned above is an understanding which states, among others, that the bidder shall enter into contract with the procuring entity and furnish the performance security required under ITB Clause 32.2, from receipt of the Notice of Award, and committing to pay the corresponding fine, and be suspended for a period of time from being qualified to participate in any government procurement activity in the event it violates any of the conditions stated therein as provided in the guidelines issued by the GPPB.

- 18.2 The bid security should be valid for the period specified in the BDS. Any bid not accompanied by an acceptable bid security shall be rejected by the Procuring Entity as non-responsive.
- 18.3 No bid securities shall be returned to bidders after the opening of bids and before contract signing, except to those that failed or declared as post-disqualified, upon submission of a written waiver of their right to file a motion for reconsideration and/or protest. Without prejudice on its forfeiture, Bid Securities shall be returned only after the bidder with the Lowest Calculated Responsive Bid has signed the contract and furnished the Performance Security, but in no case later than the expiration of the Bid Security validity period indicated in ITB Clause 18.2.
- 18.4 Upon signing and execution of the contract, pursuant to **ITB** Clause 31, and the posting of the performance security, pursuant to **ITB** Clause 32, the successful Bidder's Bid security will be discharged, but in no case later than the Bid security validity period as indicated in ITB Clause 18.2.
- 18.5 The bid security may be forfeited:
- if a Bidder:
- (i) withdraws its bid during the period of bid validity specified in **ITB** Clause 17;

- (ii) does not accept the correction of errors pursuant to **ITB** Clause 27.3(b);
 - (iii) fails to submit the requirements within the prescribed period, or a finding against their veracity, as stated in ITB Clause28.2;
 - (iv) submission of eligibility requirements containing false information or falsified documents;
 - (v) submission of bids that contain false information or falsified documents, or the concealment of such information in the bids in order to influence the outcome of eligibility screening or any other stage of the public bidding;
 - (vi) allowing the use of one's name, or using the name of another for purposes of public bidding;
 - (vii) withdrawal of a bid, or refusal to accept an award, or enter into contract with the Government without justifiable cause, after the Bidder had been adjudged as having submitted the Lowest Calculated and Responsive Bid;
 - (viii) refusal or failure to post the required performance security within the prescribed time;
 - (ix) refusal to clarify or validate in writing its bid during post-qualification within a period of seven (7) calendar days from receipt of the request for clarification;
 - (x) any documented attempt by a bidder to unduly influence the outcome of the bidding in his favor;
 - (xi) failure of the potential joint venture partners to enter into the joint venture after the bid is declared successful; or
 - (xii) all other acts that tend to defeat the purpose of the competitive bidding, such as habitually withdrawing from bidding, submitting late Bids or patently insufficient bid, for at least three (3) times within a year, except for valid reasons.
- (b) if the successful Bidder:
- (i) fails to sign the contract in accordance with **ITB** Clause 31;
 - (ii) fails to furnish performance security in accordance with **ITB** Clause32.

19. Format and Signing of Bids

- 19.1 Bidders shall submit their bids through their duly authorized representative using the appropriate forms provided in Section IX on or before the deadline specified in the **ITB** Clause 21 in two (2) separate sealed bid envelopes, and which shall be submitted simultaneously. The first shall contain the technical component of the bid, including the eligibility requirements under **ITB** Clause12.1, and the second shall contain the financial component of the bid.
- 19.2 Forms as mentioned in **ITB** Clause19.1 must be completed without any alterations to their format, and no substitute form shall be accepted. All blank spaces shall be filled in with the information requested.
- 19.3 The Bidder shall prepare an original of the first and second envelopes as described in **ITB** Clauses 12 and 13. In addition, the Bidder shall submit copies of the first and

second envelopes. In the event of any discrepancy between the original and the copies, the original shall prevail.

- 19.4 The bid, except for unamended printed literature, shall be signed, and each and every page thereof shall be initialed, by the duly authorized representative/s of the Bidder.
- 19.5 Any interlineations, erasures, or overwriting shall be valid only if they are signed or initialed by the duly authorized representative/s of the Bidder.

20. Sealing and Marking of Bids

- 20.1 Bidders shall enclose their original eligibility and technical documents described in **ITB** Clause 12 & 13, in one sealed envelope marked "ORIGINAL - TECHNICAL COMPONENT", and the original of their financial component in another sealed envelope marked "ORIGINAL - FINANCIAL COMPONENT", sealing them all in an outer envelope marked "ORIGINAL BID".
- 20.2 Each copy of the first and second envelopes shall be similarly sealed duly marking the inner envelopes as "COPY NO. ____ - TECHNICAL COMPONENT" and "COPY NO. ____ - FINANCIAL COMPONENT" and the outer envelope as "COPY NO. ____", respectively. These envelopes containing the original and the copies shall then be enclosed in one single envelope.
- 20.3 The original and the number of copies of the Bid as indicated in the BDS shall be typed or written in indelible ink and shall be signed by the bidder or its duly authorized representative/s.
- 20.4 All envelopes shall:
- (a) contain the name of the contract to be bid in capital letters;
 - (b) bear the name and address of the Bidder in capital letters;
 - (c) be addressed to the Procuring Entity's BAC identified in **ITB** Clause 10.1;
 - (d) bear the specific identification of this bidding process indicated in the Invitation to Bid; and
 - (e) bear a warning "DO NOT OPEN BEFORE..." the date and time for the opening of bids, in accordance with **ITB** Clause 21.
- 20.5 If bids are not sealed and marked as required, the Procuring Entity will assume no responsibility for the misplacement or premature opening of the bid.

D. Submission and Opening of Bids

21. Deadline for Submission of Bids

Bids must be received by the Procuring Entity's BAC at the address and on or before the date and time indicated in the BDS.

22. Late Bids

Any bid submitted after the deadline for submission and receipt of bids prescribed by the Procuring Entity, pursuant to **ITB** Clause 21, shall be declared "Late" and shall not be accepted by the Procuring Entity.

23. Modification and Withdrawal of Bids

- 23.1 The Bidder may modify its bid after it has been submitted; provided that the modification is received by the Procuring Entity prior to the deadline prescribed for submission and receipt of bids. The Bidder shall not be allowed to retrieve its original bid, but shall be allowed to submit another bid equally sealed, properly identified, linked to its original bid marked as "TECHNICAL MODIFICATION" or "FINANCIAL MODIFICATION" and stamped "received" by the BAC. Bid modifications received after the applicable deadline shall not be considered and shall be returned to the Bidder unopened.
- 23.2 A Bidder may, through a letter of withdrawal, withdraw its bid after it has been submitted, for valid and justifiable reason; provided that the letter of withdrawal is received by the Procuring Entity prior to the deadline prescribed for submission and receipt of bids.
- 23.3 Bids requested to be withdrawn in accordance with **ITB** Clause 23.1 shall be returned unopened to the Bidders. A Bidder may also express its intention not to participate in the bidding through a letter which should reach and be stamped by the BAC before the deadline for submission and receipt of bids. A Bidder that withdraws its bid shall not be permitted to submit another bid, directly or indirectly, for the same contract.
- 23.4 No bid may be modified after the deadline for submission of bids. No bid may be withdrawn in the interval between the deadline for submission of bids and the expiration of the period of bid validity specified by the Bidder on the Financial Bid Form. Withdrawal of a bid during this interval shall result in the forfeiture of the Bidder's bid security, pursuant to **ITB** Clause 18.5, and the imposition of administrative, civil, and criminal sanctions as prescribed by RA 9184 and its IRR.

24. Opening and Preliminary Examination of Bids

- 24.1 The BAC shall open the first bid envelopes of Bidders in public as specified in the BDS to determine each Bidder's compliance with the documents prescribed in **ITB** Clause 12. For this purpose, the BAC shall check the submitted documents of each bidder against a checklist of required documents to ascertain if they are all present, using a non-discretionary "pass/fail" criterion. If a bidder submits the required document, it shall be rated "passed" for that particular requirement. In this regard, bids that fail to include any requirement or are incomplete or patently insufficient shall be considered as "failed". Otherwise, the BAC shall rate the said first bid envelope as "passed".
- 24.2 Unless otherwise specified in the BDS, immediately after determining compliance with the requirements in the first envelope, the BAC shall forthwith open the second bid envelope of each remaining eligible bidder whose first bid envelope was rated "passed". The second envelope of each complying bidder shall be opened within the same day. In case one or more of the requirements in the second envelope of a particular bid is missing, incomplete or patently insufficient, and/or if the submitted total bid price exceeds the ABC unless otherwise provided in **ITB** Clause 13.1(b), the BAC shall rate the bid concerned as "failed". Only bids that are determined to contain all the bid requirements for both components shall be rated "passed" and shall immediately be considered for evaluation and comparison.
- 24.3 Letters of withdrawal shall be read out and recorded during bid opening, and the envelope containing the corresponding withdrawn bid shall be returned to the Bidder unopened. If the withdrawing Bidder's representative is in attendance, the original bid and all copies thereof shall be returned to the representative during the bid opening. If the representative is not in attendance, the Bid shall be returned unopened by registered mail. The Bidder may withdraw its bid prior to the deadline for the submission and receipt of bids, provided that the corresponding letter of withdrawal contains a valid authorization requesting for such withdrawal, subject to appropriate administrative sanctions.
- 24.4 If a Bidder has previously secured a certification from the Procuring Entity to the effect that it has previously submitted the above-enumerated Class "A" Documents, the said

certification may be submitted in lieu of the requirements enumerated in **ITB** Clause 12.1(a), items (i) to (vi).

- 24.5 In the case of an eligible foreign Bidder as described in **ITB** Clause 5, the Class “A” Documents enumerated in **ITB** Clause 12.1(a) may be substituted with the appropriate equivalent documents, if any, issued by the country of the foreign Bidder concerned.
- 24.6 Each partner of a joint venture agreement shall likewise submit the documents required in **ITB** Clauses 12.1(a)(i) and 12.1(a)(ii). Submission of documents required under **ITB** Clauses 12.1(a)(iii) to 12.1(a)(vi) by any of the joint venture partners constitutes compliance.
- 24.7 Decision of the procuring entity at any stage of the procurement process may be questioned in accordance with Section 55 of the revised Implementing Rules and Regulations of Republic Act 9184.

E. Evaluation and Comparison of Bids

25. Process to be Confidential

- 25.1 Members of the BAC, including its staff and personnel, as well as its Secretariat and TWG, are prohibited from making or accepting any kind of communication with any bidder regarding the evaluation of their bids until the issuance of the Notice of Award, unless in the case of **ITB** Clause 26.
- 25.2 Any effort by a bidder to influence the Procuring Entity in the Procuring Entity’s decision in respect of Bid evaluation, Bid comparison or contract award will result in the rejection of the Bidder’s Bid.

26. Clarification of Bids

To assist in the evaluation, comparison and post-qualification of the bids, the Procuring Entity may ask in writing any Bidder for a clarification of its bid. All responses to requests for clarification shall be in writing. Any clarification submitted by a Bidder in respect to its bid and that is not in response to a request by the Procuring Entity shall not be considered

27. Detailed Evaluation and Comparison of Bids

- 27.1 The Procuring Entity will undertake the detailed evaluation and comparison of Bids which have passed the opening and preliminary examination of Bids, pursuant to **ITB** Clause 24, in order to determine the Lowest Calculated Bid.
- 27.2 In evaluating the Bids to get the Lowest Calculated Bid, the Procuring Entity shall undertake the following:
 - (a) The detailed evaluation of the financial component of the bids, to establish the correct calculated prices of the bids; and
 - (b) The ranking of the total bid prices as so calculated from the lowest to highest. The bid with the lowest price shall be identified as the Lowest Calculated Bid.
- 27.3 The Procuring Entity’s BAC shall immediately conduct a detailed evaluation of all bids rated “passed,” using non-discretionary “pass/fail” criterion. The BAC shall consider the following in the evaluation of bids:
 - (a) Completeness of the bid. Unless the ITB specifically allows partial bids, bids not addressing or providing all of the required items in the Schedule of Requirements including, where applicable, bill of quantities, shall be considered non-responsive and, thus, automatically disqualified. In this regard, where a required item is provided, but no price is indicated, the same shall be

considered as non-responsive, but specifying a "0" (zero) for the said item would mean that it is being offered for free to the Procuring Entity; and

- (b) Arithmetical corrections. Consider computational errors and omissions to enable proper comparison of all eligible bids. It may also consider bid modifications if expressly allowed in the BDS. Any adjustment shall be calculated in monetary terms to determine the calculated prices.
- 27.4 Based on the detailed evaluation of bids, those that comply with the above-mentioned requirements shall be ranked in the ascending order of their total calculated bid prices, as evaluated and corrected for computational errors, discounts and other modifications, to identify the Lowest Calculated Bid. Total calculated bid prices, as evaluated and corrected for computational errors, discounts and other modifications, which exceed the ABC shall not be considered, unless otherwise indicated in the BDS.
- 27.5 The Procuring Entity's evaluation of bids shall only be based on the bid price quoted in the Financial Bid Form
- 27.6 Bids shall be evaluated on an equal footing to ensure fair competition. For this purpose, all bidders shall be required to include in their bids the cost of all taxes, such as, but not limited to, value added tax (VAT), income tax, local taxes, and other fiscal levies and duties which shall be itemized in the bid form and reflected in the detailed estimates. Such bids, including said taxes, shall be the basis for bid evaluation and comparison.

28. Post Qualification

- 28.1 The Procuring Entity shall determine to its satisfaction whether the Bidder that is evaluated as having submitted the Lowest Calculated Bid (LCB) complies with and is responsive to all the requirements and conditions specified in **ITB** Clauses 5, 12, and 13.
- 28.2 Within a non-extendible period of three (3) calendar days from receipt by the Bidder of the notice from the BAC that it submitted the LCB, the Bidder shall submit the following documentary requirements:
- (a) Latest income and business tax returns in the form specified in the BDS;
 - (b) Certificate of PhilGEPS Registration; and
 - (c) Other appropriate licenses and permits required by law and stated in the BDS.
- Failure of the Bidder declared as LCB to duly submit the requirements under this Clause or a finding against the veracity of such, shall be ground for forfeiture of the bid security and disqualification of the Bidder for award.
- 28.3 The determination shall be based upon an examination of the documentary evidence of the Bidder's qualifications submitted pursuant to **ITB** Clauses 12 and 13, as well as other information as the Procuring Entity deems necessary and appropriate, using a non-discretionary "pass/fail" criterion.
- 28.4 If the BAC determines that the Bidder with the Lowest Calculated Bid passes all the criteria for post-qualification, it shall declare the said bid as the Lowest Calculated Responsive Bid, and recommend to the Head of the Procuring Entity the award of contract to the said Bidder at its submitted price or its calculated bid price, whichever is lower, subject to **ITB** Clause 30.3.
- 28.5 A negative determination shall result in rejection of the Bidder's Bid, in which event the Procuring Entity shall proceed to the next Lowest Calculated Bid to make a similar determination of that Bidder's capabilities to perform satisfactorily. If the second Bidder, however, fails the post qualification, the procedure for post qualification shall be

repeated for the Bidder with the next Lowest Calculated Bid, and so on until the Lowest Calculated and Responsive Bid is determined for contract award.

- 28.6 Within a period not exceeding seven (7) calendar days from the date of receipt of the recommendation of the BAC, the Head of the Procuring Entity shall approve or disapprove the said recommendation. In the case of government owned and government-owned and/or -controlled corporations (GOCCs) and government financial institutions (GFIs), the period provided herein shall be fifteen (15) calendar days.

29. Reservation Clause

- 29.1 Notwithstanding the eligibility or post-qualification of a bidder, the Procuring Entity concerned reserves the right to review its qualifications at any stage of the procurement process if it has reasonable grounds to believe that a misrepresentation has been made by the said bidder, or that there has been a change in the Bidder's capability to undertake the project from the time it submitted its eligibility requirements. Should such review uncover any misrepresentation made in the eligibility and bidding requirements, statements or documents, or any changes in the situation of the Bidder which will affect its capability to undertake the project so that it fails the preset eligibility or bid evaluation criteria, the Procuring Entity shall consider the said Bidder as ineligible and shall disqualify it from submitting a bid or from obtaining an award or contract.
- 29.2 Based on the following grounds, the Procuring Entity reserves the right to reject any and all Bids, declare a Failure of Bidding at any time prior to the contract award, or not to award the contract, without thereby incurring any liability, and make no assurance that a contract shall be entered into as a result of the bidding:
- (a) if there is *prima facie* evidence of collusion between appropriate public officers or employees of the Procuring Entity, or between the BAC and any of the bidders, or if the collusion is between or among the bidders themselves, or between a bidder and a third party, including any act which restricts, suppresses or nullifies or tends to restrict, suppress or nullify competition;
 - (b) if the Procuring Entity's BAC is found to have failed in following the prescribed bidding procedures; or
 - (c) for any justifiable and reasonable ground where the award of the contract will not redound to the benefit of the Government as follows:
 - (i) If the physical and economic conditions have significantly changed so as to render the project no longer economically, financially or technically feasible as determined by the head of the procuring entity;
 - (ii) If the project is no longer necessary as determined by the head of the procuring entity; and
 - (iii) If the source of funds for the project has been withheld or reduced through no fault of the Procuring Entity.
- 29.3 In addition, the Procuring Entity may likewise declare a failure of bidding when:
- (a) No bids are received;
 - (b) All prospective bidders are declared ineligible;
 - (c) All bids fail to comply with all the bid requirements or fail post-qualification; or
 - (d) The bidder with the Lowest Calculated Responsive Bid refuses, without justifiable cause to accept the award of contract, and no award is made.

F. Award of Contract

30. Contract Award

- 30.1 Subject to **ITB** Clause 28, the Procuring Entity shall award the contract to the Bidder whose Bid has been determined to be the Lowest Calculated and Responsive Bid (LCRB).
- 30.2 Prior to the expiration of the period of Bid validity, the Procuring Entity shall notify the successful Bidder in writing that its Bid has been accepted, through a Notice of Award received personally or sent by registered mail or electronically, receipt of which must be confirmed in writing within two (2) days by the LCRB and submitted personally or sent by registered mail or electronically to the Procuring Entity.
- 30.3 Notwithstanding the issuance of the Notice of Award, award of contract shall be subject to the following conditions:
- (a) Submission of the following documents within the prescribed period from receipt by the Bidder of the notice that it has the Lowest Calculated and Responsive Bid:
 - (i) Valid JVA, if applicable, within ten (10) calendar days;
 - (ii) Valid PCAB license and registration for the type and cost of the contract to be bid for foreign bidders, within thirty (30) calendar days, if allowed under a Treaty or International or Executive Agreement mentioned in **ITB** Clause 12.1(a)(iv);
 - (b) Posting of the performance security in accordance with **ITB** Clause 32;
 - (c) Signing of the contract as provided in **ITB** Clause 31; and
 - (d) Approval by higher authority, if required.

31. Signing of the Contract

- 31.1 At the same time as the Procuring Entity notifies the successful Bidder that its Bid has been accepted, the Procuring Entity shall send the Contract Form to the Bidder, which Contract has been provided in the Bidding Documents, incorporating therein all agreements between the parties.
- 31.2 Within ten (10) calendar days from receipt of the Notice of Award, the successful Bidder shall post the required performance security, sign and date the contract and return it to the Procuring Entity.
- 31.3 The Procuring Entity shall enter into contract with the successful Bidder within the same ten (10) calendar day period provided that all the documentary requirements are complied with.
- 31.4 The following documents shall form part of the contract:
- (a) Contract Agreement;
 - (b) Bidding Documents;
 - (c) Winning bidder's bid, including the Technical and Financial Proposals, and all other documents/statements submitted;
 - (d) Performance Security;
 - (e) Credit line in accordance with **ITB** Clause 5.5, if applicable;

- (f) Notice of Award of Contract; and
- (g) Other contract documents that may be required by existing laws and/or specified in the BDS.

32. Performance Security

- 32.1 To guarantee the faithful performance by the winning Bidder of its obligations under the contract, it shall post a performance security within a maximum period of ten (10) calendar days from the receipt of the Notice of Award from the Procuring Entity and in no case later than the signing of the contract.
- 32.2 The performance security shall be denominated in Philippine Pesos and posted in favor of the Procuring Entity in an amount equal to the percentage of the total contract price as stated in the BDS in accordance with the following schedule:

Form of Performance Security	Amount of Performance Security (Equal to Percentage of the Total Contract Price)
(a) Cash or cashier's/manager's check issued by a Universal or Commercial Bank.	Ten percent (10%)
(b) Bank draft/guarantee or irrevocable letter of credit issued by a Universal or Commercial Bank: Provided, however, that it shall be confirmed or authenticated by a Universal or Commercial Bank, if issued by a foreign bank.	
(c) Surety bond callable upon demand issued by a surety or insurance company duly certified by the Insurance Commission as authorized to issue such security; and/or	Thirty percent (30%)
(d) Any combination of the foregoing.	Proportionate to share of form with respect to total amount of security

- 32.3 Failure of the successful Bidder to comply with the above-mentioned requirement shall constitute sufficient ground for the annulment of the award and forfeiture of the bid security, in which event the Procuring Entity shall initiate and complete the post qualification of the second Lowest Calculated Bid. The procedure shall be repeated until the Lowest Calculated and Responsive Bid is identified and selected for contract award. However, if no Bidder passed post-qualification, the BAC shall declare the bidding a failure and conduct a re-bidding with re-advertisement.

33. Notice to Proceed

- 33.1 Within three (3) calendar days from the date of approval of the Contract by the appropriate government approving authority, the Procuring Entity shall issue its Notice to Proceed to the Bidder.
- 33.2 The contract effectivity date shall be provided in the Notice to Proceed by the Procuring Entity, which date shall not be later than seven (7) calendar days from the issuance of the Notice to Proceed.

BID DATA SHEET (BDS)

Name of Project:

“RENOVATION OF HEALTH SERVICES UNIT (ITB-2024-008)

ITB CLAUSE	
1.1	<p>The PROCURING ENTITY is: UNIVERSITY OF THE PHILIPPINES VISAYAS</p> <p>The name of the contract: “RENOVATION OF HEALTH SERVICES UNIT (ITB-2024-008)</p> <p>The lot(s) and reference is/are: Invitation To Bid / Request for Expression of Interest</p>
2.0	<p>The Funding Source is:</p> <p>UGTI</p>
5.1	No further instructions
5.2	Bidding is restricted to eligible bidders as defined in ITB Clause 5.1
5.4	The Bidder must have an experience of having completed at least one (1) contract that is similar to this Project, equivalent to at least fifty per cent (50%) of the ABC adjusted to current prices using the National Statistic Office consumer price index. However, contractors under Small A and Small B categories without similar experience on the contract to be bid may be allowed to bid if the cost of such contract is not more than fifty percent (50%) of the Allowable Range of the Contract Cost (ARCC) of their registration based on the guidelines as prescribed by the PCAB.
8.1 & 8.2	Sub Contract is not allowed
9.1(a) & (b)	<p>The Time and Venue of Pre-Bid Conference is:</p> <p>05 April 2024, 9:00AM CM12, College of Management Bldg., UP Visayas, Iloilo City</p>
9.1(a) & (b)	No Further Instructions
10.1	<p>The PROCURING ENTITY’S address is:</p> <p style="padding-left: 40px;">University of the Philippines Visayas Iloilo City</p> <p style="padding-left: 40px;">MS. ARLENE N. AVANCEÑA Chair, Bids and Awards Committee</p> <p style="padding-left: 40px;">Tel. No.: (033) 336-55-64 / 336-55-63 CP# 09171475733</p> <p style="padding-left: 40px;">E-mail Address: bac@upv.edu.ph</p>
12.1	See checklist for Eligibility Requirements and Technical Documents
13.1 (b)	Refer to the Checklist of Financial Requirements

13.2 (a) &(b)	<p>The total ABC is: Php 1,994,364.67</p> <p>Any Bid with a total financial proposal exceeding this amount shall not be accepted.</p>
17.1	<p>Period for Validity of Bids</p> <p>Bids will be valid until 120 days from the date of the opening of Bids.</p>
18.1	<p>Bid Security Bid Security shall be in any of the following :</p> <ul style="list-style-type: none"> a) Cashier's / manager's check issued by a Universal or Commercial Bank = 2% of Php 1,994,364.67 in the amount of: P 39,887.29 b) Bank draft/guarantee or Irrevocable letter of credit issued by a Universal or Commercial Bank: Provided, however, that it shall be confirmed or authenticated by a Universal or Commercial Bank, if issued by a foreign bank = 2% of Php 1,994,364.67 in the amount of: P 39,887.29 c) Bid Securing Declaration <p>NOTE:</p> <p style="text-align: center;">CASH AND SURETY BOND ARE NOT ACCEPTABLE</p> <p style="text-align: center;">All checks must be payable to: "U.P. VISAYAS"</p>
18.2	<p>Bid Security Validity</p> <p>Bid security will be valid until 120 days from the date of the opening of Bids.</p>

20.3	<p>Sealing and Marking of Bids:</p> <p>Bidders shall submit the following:</p> <p>Envelope 1 – shall contain eligibility and technical component marked original copy- TECHNICAL, copy 1- TECHNICAL and copy 2 – TECHNICAL. It should be sealed and marked Eligibility and Technical Component</p> <p>Envelope 2 – shall contain financial component marked original copy – FINANCIAL, copy 1 – FINANCIAL and copy 2 – FINANCIAL. It should be sealed and marked Financial Component</p> <p>Envelope 1 and Envelope 2 must be sealed in another outer envelope for submission.</p> <p>All folders and envelopes shall:</p> <ul style="list-style-type: none"> (a) contain the name of the contract to be bid in capital letters; (b) bear the name and address of the Bidder in capital letters; © be addressed to the Procuring Entity’s BAC identified in BDS Clause 10.1; (31) bear the specific identification of this bidding process indicated in the Invitation to Bid; and © bear a warning “DO NOT OPEN BEFORE 19 April 2024, 9:00AM” the date and time for the opening of bids, in accordance with ITB Clause 21. <p>If bids are not sealed and marked as required, the Procuring Entity will assume no responsibility for the misplacement or premature opening of the bid.</p> <p>In relation to Items 12 and 13 of the Instruction to Bidders, all prospective bidders are required to submit the original copy of the Eligibility, Technical and Financial Documents.</p> <p>Bidders may submit either an original copy or a certified true copy of the following documents:</p> <ul style="list-style-type: none"> 31. All class “A” Legal Documents such as Certificate of Registration from SEC, DTI, CDA, Mayor’s permit from city of municipality; 2. Class “A” Financial Documents of the prospective bidder’s audited financial statements, stamped “received” by the Bureau of Internal Revenue; 3. Copy 1 and Copy 2 of the Eligibility, Technical and Financial Documents. <p>All other provisions of the Eligibility Requirements Checklist and Forms are not mentioned here must prevail.</p>
21.	<p>The Address for Submission of Bids is: CM12, College of Management Bldg., UP Visayas, Iloilo City</p> <p>The deadline for Submission of Bids is: 19 April 2024, 9:00AM</p>

24.1	<p>The place of Bid opening is: CM12, College of Management Bldg., UP Visayas, Iloilo City</p> <p>The time and date of Bid opening is: 19 April 2024, 9:00AM</p>									
27.3(b)	<p>The Procuring Entity's BAC shall immediately conduct a detailed evaluation of the bids rated "passed" using non-discretionary pass/fail criteria. Unless otherwise specified in the BDS, the BAC shall consider the following in the evaluation of bids:</p> <p>a) Bid Proposals shall be on a By-Lot basis. Prospective bidders must submit offer for all items listed in the Bill of Quantities per Lot. "NO BID" submitted in any of the items shall mean no bid for the whole lot.</p> <p>b) Minor arithmetical corrections to consider computational errors, omissions and discounts to enable proper comparison of all eligible bids. Any adjustment shall be calculated in monetary terms to determine the calculated prices.</p>									
32.2	<table border="1"> <thead> <tr> <th data-bbox="379 770 970 887">Form of Performance Security</th> <th data-bbox="978 770 1358 887">Amount of Performance Security (Equal to Percentage of the Total Contract Price)</th> </tr> </thead> <tbody> <tr> <td data-bbox="379 893 970 976">(a) Cash or cashier's/manager's check issued by a Universal or Commercial Bank.</td> <td data-bbox="978 893 1358 1162" rowspan="2">Ten percent (10%)</td> </tr> <tr> <td data-bbox="379 983 970 1162">(b) Bank draft/guarantee or irrevocable letter of credit issued by a Universal or Commercial Bank: Provided, however, that it shall be confirmed or authenticated by a Universal or Commercial Bank, if issued by a foreign bank.</td> </tr> <tr> <td data-bbox="379 1169 970 1308">(c) Surety bond callable upon demand issued by a surety or insurance company duly certified by the Insurance Commission as authorized to issue such security; and/or</td> <td data-bbox="978 1169 1358 1308">Thirty percent (30%)</td> </tr> </tbody> </table>	Form of Performance Security	Amount of Performance Security (Equal to Percentage of the Total Contract Price)	(a) Cash or cashier's/manager's check issued by a Universal or Commercial Bank.	Ten percent (10%)	(b) Bank draft/guarantee or irrevocable letter of credit issued by a Universal or Commercial Bank: Provided, however, that it shall be confirmed or authenticated by a Universal or Commercial Bank, if issued by a foreign bank.	(c) Surety bond callable upon demand issued by a surety or insurance company duly certified by the Insurance Commission as authorized to issue such security; and/or	Thirty percent (30%)		
Form of Performance Security	Amount of Performance Security (Equal to Percentage of the Total Contract Price)									
(a) Cash or cashier's/manager's check issued by a Universal or Commercial Bank.	Ten percent (10%)									
(b) Bank draft/guarantee or irrevocable letter of credit issued by a Universal or Commercial Bank: Provided, however, that it shall be confirmed or authenticated by a Universal or Commercial Bank, if issued by a foreign bank.										
(c) Surety bond callable upon demand issued by a surety or insurance company duly certified by the Insurance Commission as authorized to issue such security; and/or	Thirty percent (30%)									

Section IV. General Conditions of Contract

Notes on the General Conditions of Contract

The details in the GCC and SCC, and submission thereof, along with other required documents listed therein, expressing all the rights and obligations of the parties, should be complete.

The GCC herein shall not be altered. Any changes and complementary information, which may be needed, shall be introduced only through the SCC.

31. Definitions

For purposes of this Clause, boldface type is used to identify defined terms.

- 1.1 The **Arbiter** is the person appointed jointly by the Procuring Entity and the Contractor to resolve disputes in the first instance, as provided for in **GCC** Clause 21.
- 1.2 **Bill of Quantities** refers to a list of the specific items of the Work and their corresponding unit prices, lump sums, and/or provisional sums.
- 1.3 The **Completion Date** is the date of completion of the Works as certified by the Procuring Entity's Representative, in accordance with **GCC** Clause 49.
- 1.4 The **Contract** is the contract between the Procuring Entity and the Contractor to execute, complete, and maintain the Works.
- 1.5 The **Contract Price** is the price stated in the Letter of Acceptance and thereafter to be paid by the Procuring Entity to the Contractor for the execution of the Works in accordance with this Contract.
- 1.6 **Contract Time Extension** is the allowable period for the Contractor to complete the Works in addition to the original Completion Date stated in this Contract.
- 1.7 The **Contractor** is the juridical entity whose proposal has been accepted by the Procuring Entity and to whom the Contract to execute the Work was awarded.
- 1.8 The **Contractor's Bid** is the signed offer or proposal submitted by the Contractor to the Procuring Entity in response to the Bidding Documents.
- 1.9 **Days** are calendar days; months are calendar months.
- 1.10 **Dayworks** are varied work inputs subject to payment on a time basis for the Contractor's employees and Equipment, in addition to payments for associated Materials and Plant.
- 1.11 A **Defect** is any part of the Works not completed in accordance with the Contract.
- 1.12 The **Defects Liability Certificate** is the certificate issued by Procuring Entity's Representative upon correction of defects by the Contractor.
- 1.13 The **Defects Liability Period** is the one year period between contract completion and final acceptance within which the Contractor assumes the responsibility to undertake the repair of any damage to the Works at his own expense.
- 1.14 **Drawings** are graphical presentations of the Works. They include all supplementary details, shop drawings, calculations, and other information provided or approved for the execution of this Contract.
- 1.15 **Equipment** refers to all facilities, supplies, appliances, materials or things required for the execution and completion of the Work provided by the Contractor and which shall not form or are not intended to form part of the Permanent Works.
- 1.16 The **Intended Completion Date** refers to the date specified in the SCC when the Contractor is expected to have completed the Works. The Intended Completion Date may be revised only by the Procuring Entity's Representative by issuing an extension of time or an acceleration order.
- 1.17 **Materials** are all supplies, including consumables, used by the Contractor for incorporation in the Works.

- 1.18 The **Notice to Proceed** is a written notice issued by the Procuring Entity or the Procuring Entity's Representative to the Contractor requiring the latter to begin the commencement of the work not later than a specified or determinable date.
- 1.19 **Permanent Works** all permanent structures and all other project features and facilities required to be constructed and completed in accordance with this Contract which shall be delivered to the Procuring Entity and which shall remain at the Site after the removal of all Temporary Works.
- 1.20 **Plant** refers to the machinery, apparatus, and the like intended to form an integral part of the Permanent Works.
- 1.21 The **Procuring Entity** is the party who employs the Contractor to carry out the Works stated in the SCC.
- 1.22 The **Procuring Entity's Representative** refers to the Head of the Procuring Entity or his duly authorized representative, identified in the SCC, who shall be responsible for supervising the execution of the Works and administering this Contract.
- 1.23 The **Site** is the place provided by the Procuring Entity where the Works shall be executed and any other place or places which may be designated in the SCC, or notified to the Contractor by the Procuring Entity's Representative as forming part of the Site.
- 1.24 **Site Investigation Reports** are those that were included in the Bidding Documents and are factual and interpretative reports about the surface and subsurface conditions at the Site.
- 1.25 **Slippage** is a delay in work execution occurring when actual accomplishment falls below the target as measured by the difference between the scheduled and actual accomplishment of the Work by the Contractor as established from the work schedule. This is actually described as a percentage of the whole Works.
- 1.26 **Specifications** means the description of Works to be done and the qualities of materials to be used, the equipment to be installed and the mode of construction.
- 1.27 The **Start Date**, as specified in the SCC, is the date when the Contractor is obliged to commence execution of the Works. It does not necessarily coincide with any of the Site Possession Dates.
- 1.28 A **Subcontractor** is any person or organization to whom a part of the Works has been subcontracted by the Contractor, as allowed by the Procuring Entity, but not any assignee of such person.
- 1.29 **Temporary Works** are works designed, constructed, installed, and removed by the Contractor that are needed for construction or installation of the Permanent Works.
- 1.30 **Work(s)** refer to the Permanent Works and Temporary Works to be executed by the Contractor in accordance with this Contract, including (i) the furnishing of all labor, materials, equipment and others incidental, necessary or convenient to the complete execution of the Works; (ii) the passing of any tests before acceptance by the Procuring Entity's Representative; (iii) and the carrying out of all duties and obligations of the Contractor imposed by this Contract as described in the SCC.

2. Interpretation

- 2.1 In interpreting the Conditions of Contract, singular also means plural, male also means female or neuter, and the other way around. Headings have no significance. Words have their normal meaning under the language of this Contract unless specifically

defined. The Procuring Entity's Representative will provide instructions clarifying queries about the Conditions of Contract.

- 2.2 If sectional completion is specified in the SCC, references in the Conditions of Contract to the Works, the Completion Date, and the Intended Completion Date apply to any Section of the Works (other than references to the Completion Date and Intended Completion Date for the whole of the Works).

3. Governing Language and Law

3.1 This Contract has been executed in the English language, which shall be the binding and controlling language for all matters relating to the meaning or interpretation of this Contract. All correspondence and other documents pertaining to this Contract which are exchanged by the parties shall be written in English.

3.2 This Contract shall be interpreted in accordance with the laws of the Republic of the Philippines.

4. Communications

Communications between parties that are referred to in the Conditions shall be effective only when in writing. A notice shall be effective only when it is received by the concerned party.

5. Possession of Site

5.1 On the date specified in the SCC, the Procuring Entity shall grant the Contractor possession of so much of the Site as may be required to enable it to proceed with the execution of the Works. If the Contractor suffers delay or incurs cost from failure on the part of the Procuring Entity to give possession in accordance with the terms of this clause, the Procuring Entity's Representative shall give the Contractor a Contract Time Extension and certify such sum as fair to cover the cost incurred, which sum shall be paid by Procuring Entity.

5.2 If possession of a portion is not given by the date stated in the SCC Clause 5.1, the Procuring Entity will be deemed to have delayed the start of the relevant activities. The resulting adjustments in contract time to address such delay shall be in accordance with **GCC** Clause 47.

5.3 The Contractor shall bear all costs and charges for special or temporary right-of-way required by it in connection with access to the Site. The Contractor shall also provide at his own cost any additional facilities outside the Site required by it for purposes of the Works.

5.4 The Contractor shall allow the Procuring Entity's Representative and any person authorized by the Procuring Entity's Representative access to the Site and to any place where work in connection with this Contract is being carried out or is intended to be carried out.

6. The Contractor's Obligations

6.1 The Contractor shall carry out the Works properly and in accordance with this Contract. The Contractor shall provide all supervision, labor, Materials, Plant and Contractor's Equipment, which may be required. All Materials and Plant on Site shall be deemed to be the property of the Procuring Entity.

6.2 The Contractor shall commence execution of the Works on the Start Date and shall carry out the Works in accordance with the Program of Work submitted by the Contractor, as updated with the approval of the Procuring Entity's Representative, and complete them by the Intended Completion Date.

- 6.3 The Contractor shall be responsible for the safety of all activities on the Site.
- 6.4 The Contractor shall carry out all instructions of the Procuring Entity's Representative that comply with the applicable laws where the Site is located.
- 6.5 The Contractor shall employ the key personnel named in the Schedule of Key Personnel, as referred to in the SCC, to carry out the supervision of the Works. The Procuring Entity will approve any proposed replacement of key personnel only if their relevant qualifications and abilities are equal to or better than those of the personnel listed in the Schedule.
- 6.6 If the Procuring Entity's Representative asks the Contractor to remove a member of the Contractor's staff or work force, for justifiable cause, the Contractor shall ensure that the person leaves the Site within seven (7) days and has no further connection with the Work in this Contract.
- 6.7 During Contract implementation, the Contractor and his subcontractors shall abide at all times by all labor laws, including child labor related enactments, and other relevant rules.
- 6.8 The Contractor shall submit to the Procuring Entity for consent the name and particulars of the person authorized to receive instructions on behalf of the Contractor.
- 6.9 The Contractor shall cooperate and share the Site with other contractors, public authorities, utilities, and the Procuring Entity between the dates given in the schedule of other contractors particularly when they shall require access to the Site. The Contractor shall also provide facilities and services for them during this period. The Procuring Entity may modify the schedule of other contractors, and shall notify the Contractor of any such modification thereto.
- 6.10 Should anything of historical or other interest or of significant value be unexpectedly discovered on the Site, it shall be the property of the Procuring Entity. The Contractor shall notify the Procuring Entity's Representative of such discoveries and carry out the Procuring Entity's Representative's instructions in dealing with them.

7. Performance Security

- 7.1 Within ten (10) calendar days from receipt of the Notice of Award from the Procuring Entity but in no case later than the signing of the contract by both parties, the Contractor shall furnish the performance security in any the forms prescribed in **ITB** Clause 32.2.
- 7.2 The performance security posted in favor of the Procuring Entity shall be forfeited in the event it is established that the Contractor is in default in any of its obligations under the Contract.
- 7.3 The performance security shall remain valid until issuance by the Procuring Entity of the Certificate of Final Acceptance.
- 7.4 The performance security may be released by the Procuring Entity and returned to the Contractor after the issuance of the Certificate of Final Acceptance subject to the following conditions:
 - (a) There are no pending claims against the Contractor or the surety company filed by the Procuring Entity;
 - (b) The Contractor has no pending claims for labor and materials filed against it; and
 - © Other terms specified in the SCC.

- 7.5 The Contractor shall post an additional performance security following the amount and form specified in **ITB** Clause 32.2 to cover any cumulative increase of more than ten percent (10%) over the original value of the contract as a result of amendments to order or change orders, extra work orders and supplemental agreements, as the case may be. The Contractor shall cause the extension of the validity of the performance security to cover approved contract time extensions.
- 7.6 In case of a reduction in the contract value or for partially completed Works under the contract which are usable and accepted by the Procuring Entity the use of which, in the judgment of the implementing agency or the Procuring Entity, will not affect the structural integrity of the entire project, the Procuring Entity shall allow a proportional reduction in the original performance security, provided that any such reduction is more than ten percent (10%) and that the aggregate of such reductions is not more than fifty percent (50%) of the original performance security.
- 7.7 Unless otherwise indicated in the SCC, the Contractor, by entering into the Contract with the Procuring Entity, acknowledges the right of the Procuring Entity to institute action pursuant to Act 3688 against any subcontractor be they an individual, firm, partnership, corporation, or association supplying the Contractor with labor, materials and/or equipment for the performance of this Contract.

8. Subcontracting

- 8.1 Unless otherwise indicated in the SCC, the Contractor cannot subcontract Works more than the percentage specified in **ITB** Clause 8.1.
- 8.2 Subcontracting of any portion of the Works does not relieve the Contractor of any liability or obligation under this Contract. The Contractor will be responsible for the acts, defaults, and negligence of any subcontractor, its agents, servants or workmen as fully as if these were the Contractor's own acts, defaults, or negligence, or those of its agents, servants or workmen.
- 8.3 Subcontractors disclosed and identified during the bidding may be changed during the implementation of this Contract, subject to compliance with the required qualifications and the approval of the Procuring Entity.

9. Liquidated Damages

- 9.1 The Contractor shall pay liquidated damages to the Procuring Entity for each day that the Completion Date is later than the Intended Completion Date. The applicable liquidated damages is at least one-tenth (1/10) of a percent of the cost of the unperformed portion for every day of delay. The total amount of liquidated damages shall not exceed ten percent (10%) of the amount of the contract. The Procuring Entity may deduct liquidated damages from payments due to the Contractor. Payment of liquidated damages shall not affect the Contractor. Once the cumulative amount of liquidated damages reaches ten percent (10%) of the amount of this Contract, the Procuring Entity shall rescind this Contract, without prejudice to other courses of action and remedies open to it.
- 9.2 If the Intended Completion Date is extended after liquidated damages have been paid, the Engineer of the Procuring Entity shall correct any overpayment of liquidated damages by the Contractor by adjusting the next payment certificate. The Contractor shall be paid interest on the overpayment, calculated from the date of payment to the date of repayment, at the rates specified in **GCC** Clause 40.3.

10. Site Investigation Reports

The Contractor, in preparing the Bid, shall rely on any Site Investigation Reports referred to in the SCC supplemented by any information obtained by the Contractor.

11. The Procuring Entity, Licenses and Permits

The Procuring Entity shall, if requested by the Contractor, assist him in applying for permits, licenses or approvals, which are required for the Works.

12. Contractor's Risk and Warranty Security

12.1 The Contractor shall assume full responsibility for the Works from the time project construction commenced up to final acceptance by the Procuring Entity and shall be held responsible for any damage or destruction of the Works except those occasioned by *force majeure*. The Contractor shall be fully responsible for the safety, protection, security, and convenience of his personnel, third parties, and the public at large, as well as the Works, Equipment, installation, and the like to be affected by his construction work.

12.2 The defects liability period for infrastructure projects shall be one year from contract completion up to final acceptance by the Procuring Entity. During this period, the Contractor shall undertake the repair works, at his own expense, of any damage to the Works on account of the use of materials of inferior quality within ninety (90) days from the time the Head of the Procuring Entity has issued an order to undertake repair. In case of failure or refusal to comply with this mandate, the Procuring Entity shall undertake such repair works and shall be entitled to full reimbursement of expenses incurred therein upon demand.

12.3 Unless otherwise indicated in the SCC, in case the Contractor fails to comply with the preceding paragraph, the Procuring Entity shall forfeit its performance security, subject its property(ies) to attachment or garnishment proceedings, and perpetually disqualify it from participating in any public bidding. All payables of the GOP in his favor shall be offset to recover the costs.

12.4 After final acceptance of the Works by the Procuring Entity, the Contractor shall be held responsible for "Structural Defects", *i.e.*, major faults/flaws/deficiencies in one or more key structural elements of the project which may lead to structural failure of the completed elements or structure, or "Structural Failures", *i.e.*, where one or more key structural elements in an infrastructure facility fails or collapses, thereby rendering the facility or part thereof incapable of withstanding the design loads, and/or endangering the safety of the users or the general public:

- (a) Contractor – Where Structural Defects/Failures arise due to faults attributable to improper construction, use of inferior quality/substandard materials, and any violation of the contract plans and specifications, the contractor shall be held liable;
- (b) Consultants – Where Structural Defects/Failures arise due to faulty and/or inadequate design and specifications as well as construction supervision, then the consultant who prepared the design or undertook construction supervision for the project shall be held liable;
- © Procuring Entity's Representatives/Project Manager/Construction Managers and Supervisors – The project owner's representative(s), project manager, construction manager, and supervisor(s) shall be held liable in cases where the Structural Defects/Failures are due to his/their willful intervention in altering the designs and other specifications; negligence or omission in not approving or acting on proposed changes to noted defects or deficiencies in the design

and/or specifications; and the use of substandard construction materials in the project;

(31) Third Parties – Third Parties shall be held liable in cases where Structural Defects/Failures are caused by work undertaken by them such as leaking pipes, diggings or excavations, underground cables and electrical wires, underground tunnel, mining shaft and the like, in which case the applicable warranty to such structure should be levied to third parties for their construction or restoration works.

© Users – In cases where Structural Defects/Failures are due to abuse/misuse by the end user of the constructed facility and/or non-compliance by a user with the technical design limits and/or intended purpose of the same, then the user concerned shall be held liable.

12.5 The warranty against Structural Defects/Failures, except those occasioned on force majeure, shall cover the period specified in the SCC reckoned from the date of issuance of the Certificate of Final Acceptance by the Procuring Entity.

12.6 The Contractor shall be required to put up a warranty security in the form of cash, bank guarantee, letter of credit, GSIS or surety bond callable on demand, in accordance with the following schedule:

Form of Warranty	Minimum Amount in Percentage (%) of Total Contract Price
Cash or letter of credit issued by Universal or Commercial bank: provided, however, that the letter of credit shall be confirmed or authenticated by a Universal or Commercial bank, if issued by a foreign bank	Five Percent (5%)
Bank guarantee confirmed by Universal or Commercial bank: provided, however, that the letter of credit shall be confirmed or authenticated by a Universal or Commercial bank, if issued by a foreign bank	Ten Percent (10%)
Surety bond callable upon demand issued by GSIS or any surety or insurance company duly certified by the Insurance Commission	Thirty Percent (30%)

12.7 The warranty security shall be stated in Philippine Pesos and shall remain effective for one year from the date of issuance of the Certificate of Final Acceptance by the Procuring Entity, and returned only after the lapse of said one year period.

12.8 In case of structural defects/failure occurring during the applicable warranty period provided in **GCC** Clause 12.5, the Procuring Entity shall undertake the necessary restoration or reconstruction works and shall be entitled to full reimbursement by the parties found to be liable for expenses incurred therein upon demand, without prejudice to the filing of appropriate administrative, civil, and/or criminal charges against the responsible persons as well as the forfeiture of the warranty security posted in favor of the Procuring Entity.

13. Liability of the Contractor

Subject to additional provisions, if any, set forth in the SCC, the Contractor’s liability under this Contract shall be as provided by the laws of the Republic of the Philippines.

14. Procuring Entity’s Risk

14.1 From the Start Date until the Certificate of Final Acceptance has been issued, the following are risks of the Procuring Entity:

(a) The risk of personal injury, death, or loss of or damage to property (excluding the Works, Plant, Materials, and Equipment), which are due to:

- (i) any type of use or occupation of the Site authorized by the Procuring Entity after the official acceptance of the works; or
 - (ii) negligence, breach of statutory duty, or interference with any legal right by the Procuring Entity or by any person employed by or contracted to him except the Contractor.
- (b) The risk of damage to the Works, Plant, Materials, and Equipment to the extent that it is due to a fault of the Procuring Entity or in the Procuring Entity's design, or due to war or radioactive contamination directly affecting the country where the Works are to be executed.

15. Insurance

- 15.1 The Contractor shall, under his name and at his own expense, obtain and maintain, for the duration of this Contract, the following insurance coverage:
- (a) Contractor's All Risk Insurance;
 - (b) Transportation to the project Site of Equipment, Machinery, and Supplies owned by the Contractor;
 - © Personal injury or death of Contractor's employees; and
 - (d) Comprehensive insurance for third party liability to Contractor's direct or indirect act or omission causing damage to third persons.
- 15.2 The Contractor shall provide evidence to the Procuring Entity's Representative that the insurances required under this Contract have been effected and shall, within a reasonable time, provide copies of the insurance policies to the Procuring Entity's Representative. Such evidence and such policies shall be provided to the Procuring Entity's through the Procuring Entity's Representative.
- 15.3 The Contractor shall notify the insurers of changes in the nature, extent, or program for the execution of the Works and ensure the adequacy of the insurances at all times in accordance with the terms of this Contract and shall produce to the Procuring Entity's Representative the insurance policies in force including the receipts for payment of the current premiums.
- The above insurance policies shall be obtained from any reputable insurance company approved by the Procuring Entity's Representative.
- 15.4 If the Contractor fails to obtain and keep in force the insurances referred to herein or any other insurance which he may be required to obtain under the terms of this Contract, the Procuring Entity may obtain and keep in force any such insurances and pay such premiums as may be necessary for the purpose. From time to time, the Procuring Entity may deduct the amount it shall pay for said premiums including twenty five percent (25%) therein from any monies due, or which may become due, to the Contractor, without prejudice to the Procuring Entity exercising its right to impose other sanctions against the Contractor pursuant to the provisions of this Contract.
- 15.5 In the event the Contractor fails to observe the above safeguards, the Procuring Entity may, at the Contractor's expense, take whatever measure is deemed necessary for its protection and that of the Contractor's personnel and third parties, and/or order the interruption of dangerous Works. In addition, the Procuring Entity may refuse to make the payments under **GCC** Clause 40 until the Contractor complies with this Clause.
- 15.6 The Contractor shall immediately replace the insurance policy obtained as required in this Contract, without need of the Procuring Entity's demand, with a new policy issued

by a new insurance company acceptable to the Procuring Entity for any of the following grounds:

- (a) The issuer of the insurance policy to be replaced has:
 - (i) become bankrupt;
 - (ii) been placed under receivership or under a management committee;
 - (iii) been sued for suspension of payment; or
 - (iv) been suspended by the Insurance Commission and its license to engage in business or its authority to issue insurance policies cancelled; or
 - (v) Where reasonable grounds exist that the insurer may not be able, fully and promptly, to fulfill its obligation under the insurance policy.

16. Termination for Default of Contractor

- 16.1 The Procuring Entity shall terminate this Contract for default when any of the following conditions attend its implementation:
- 16.2 Due to the Contractor's fault and while the project is on-going, it has incurred negative slippage of fifteen percent (15%) or more in accordance with Presidential Decree 1870, regardless of whether or not previous warnings and notices have been issued for the Contractor to improve his performance;
- 16.3 Due to its own fault and after this Contract time has expired, the Contractor incurs delay in the completion of the Work after this Contract has expired; or
- 16.4 The Contractor:
 - (a) abandons the contract Works, refuses or fails to comply with a valid instruction of the Procuring Entity or fails to proceed expeditiously and without delay despite a written notice by the Procuring Entity;
 - (b) does not actually have on the project Site the minimum essential equipment listed on the Bid necessary to prosecute the Works in accordance with the approved Program of Work and equipment deployment schedule as required for the project;
 - © does not execute the Works in accordance with this Contract or persistently or flagrantly neglects to carry out its obligations under this Contract;
- (31) neglects or refuses to remove materials or to perform a new Work that has been rejected as defective or unsuitable; or
 - © sub-lets any part of this Contract without approval by the Procuring Entity.
- 16.5 All materials on the Site, Plant, Equipment, and Works shall be deemed to be the property of the Procuring Entity if this Contract is rescinded because of the Contractor's default.

17. Termination for Default of Procuring Entity

The Contractor may terminate this Contract with the Procuring Entity if the works are completely stopped for a continuous period of at least sixty (60) calendar days through no fault of its own, due to any of the following reasons:

- (a) Failure of the Procuring Entity to deliver, within a reasonable time, supplies, materials, right-of-way, or other items it is obligated to furnish under the terms of this Contract; or
- (b) The prosecution of the Work is disrupted by the adverse peace and order situation, as certified by the Armed Forces of the Philippines Provincial Commander and approved by the Secretary of National Defense.

18. Termination for Other Causes

18.1 The Procuring Entity may terminate this Contract, in whole or in part, at any time for its convenience. The Head of the Procuring Entity may terminate this Contract for the convenience of the Procuring Entity if he has determined the existence of conditions that make Project Implementation economically, financially or technically impractical and/or unnecessary, such as, but not limited to, fortuitous event(s) or changes in law and National Government policies.

18.2 The Procuring Entity or the Contractor may terminate this Contract if the other party causes a fundamental breach of this Contract.

18.3 Fundamental breaches of Contract shall include, but shall not be limited to, the following:

- (a) The Contractor stops work for twenty eight (28) days when no stoppage of work is shown on the current Program of Work and the stoppage has not been authorized by the Procuring Entity's Representative;
- (b) The Procuring Entity's Representative instructs the Contractor to delay the progress of the Works, and the instruction is not withdrawn within twenty eight (28) days;
- © The Procuring Entity shall terminate this Contract if the Contractor is declared bankrupt or insolvent as determined with finality by a court of competent jurisdiction. In this event, termination will be without compensation to the Contractor, provided that such termination will not prejudice or affect any right of action or remedy which has accrued or will accrue thereafter to the Procuring Entity and/or the Contractor. In the case of the Contractor's insolvency, any Contractor's Equipment which the Procuring Entity instructs in the notice is to be used until the completion of the Works;

(31) A payment certified by the Procuring Entity's Representative is not paid by the Procuring Entity to the Contractor within eighty four (84) days from the date of the Procuring Entity's Representative's certificate;

- © The Procuring Entity's Representative gives Notice that failure to correct a particular Defect is a fundamental breach of Contract and the Contractor fails to correct it within a reasonable period of time determined by the Procuring Entity's Representative;
- (f) The Contractor does not maintain a Security, which is required;
- (g) The Contractor has delayed the completion of the Works by the number of days for which the maximum amount of liquidated damages can be paid, as defined in the **GCC** Clause 9; and
- (h) In case it is determined prima facie by the Procuring Entity that the Contractor has engaged, before or during the implementation of the contract, in unlawful

deeds and behaviors relative to contract acquisition and implementation, such as, but not limited to, the following:

- (i) corrupt, fraudulent, collusive, coercive, and obstructive practices as defined in **ITB** Clause 3.1(a), unless otherwise specified in the SCC;
- (ii) drawing up or using forged documents;
- (iii) using adulterated materials, means or methods, or engaging in production contrary to rules of science or the trade; and
- (iv) any other act analogous to the foregoing.

18.4 The Funding Source or the Procuring Entity, as appropriate, will seek to impose the maximum civil, administrative and/or criminal penalties available under the applicable law on individuals and organizations deemed to be involved with corrupt, fraudulent, or coercive practices.

18.5 When persons from either party to this Contract gives notice of a fundamental breach to the Procuring Entity's Representative in order to terminate the existing contract for a cause other than those listed under **GCC** Clause 18.3, the Procuring Entity's Representative shall decide whether the breach is fundamental or not.

18.6 If this Contract is terminated, the Contractor shall stop work immediately, make the Site safe and secure, and leave the Site as soon as reasonably possible.

19. Procedures for Termination of Contracts

19.1 The following provisions shall govern the procedures for the termination of this Contract:

- (a) Upon receipt of a written report of acts or causes which may constitute ground(s) for termination as aforementioned, or upon its own initiative, the Procuring Entity shall, within a period of seven (7) calendar days, verify the existence of such ground(s) and cause the execution of a Verified Report, with all relevant evidence attached;
- (b) Upon recommendation by the Procuring Entity, the Head of the Procuring Entity shall terminate this Contract only by a written notice to the Contractor conveying the termination of this Contract. The notice shall state:
 - (i) that this Contract is being terminated for any of the ground(s) aforementioned, and a statement of the acts that constitute the ground(s) constituting the same;
 - (ii) the extent of termination, whether in whole or in part;
 - (iii) an instruction to the Contractor to show cause as to why this Contract should not be terminated; and
 - (iv) special instructions of the Procuring Entity, if any.

The Notice to Terminate shall be accompanied by a copy of the Verified Report;

- © Within a period of seven (7) calendar days from receipt of the Notice of Termination, the Contractor shall submit to the Head of the Procuring Entity a verified position paper stating why the contract should not be terminated. If the Contractor fails to show cause after the lapse of the seven (7) day period, either

by inaction or by default, the Head of the Procuring Entity shall issue an order terminating the contract;

(31) The Procuring Entity may, at anytime before receipt of the Bidder's verified position paper described in item © above withdraw the Notice to Terminate if it is determined that certain items or works subject of the notice had been completed, delivered, or performed before the Contractor's receipt of the notice;

© Within a non-extendible period of ten (10) calendar days from receipt of the verified position paper, the Head of the Procuring Entity shall decide whether or not to terminate this Contract. It shall serve a written notice to the Contractor of its decision and, unless otherwise provided in the said notice, this Contract is deemed terminated from receipt of the Contractor of the notice of decision. The termination shall only be based on the ground(s) stated in the Notice to Terminate; and

(f) The Head of the Procuring Entity may create a Contract Termination Review Committee (CTRC) to assist him in the discharge of this function. All decisions recommended by the CTRC shall be subject to the approval of the Head of the Procuring Entity.

19.2 Pursuant to Section 69(f) of RA 9184 and without prejudice to the imposition of additional administrative sanctions as the internal rules of the agency may provide and/or further criminal prosecution as provided by applicable laws, the procuring entity shall impose on contractors after the termination of the contract the penalty of suspension for one (1) year for the first offense, suspension for two (2) years for the second offense from participating in the public bidding process, for violations committed during the contract implementation stage, which include but not limited to the following:

(a) Failure of the contractor, due solely to his fault or negligence, to mobilize and start work or performance within the specified period in the Notice to Proceed ("NTP");

(b) Failure by the contractor to fully and faithfully comply with its contractual obligations without valid cause, or failure by the contractor to comply with any written lawful instruction of the procuring entity or its representative(s) pursuant to the implementation of the contract. For the procurement of infrastructure projects or consultancy contracts, lawful instructions include but are not limited to the following:

(i) Employment of competent technical personnel, competent engineers and/or work supervisors;

(ii) Provision of warning signs and barricades in accordance with approved plans and specifications and contract provisions;

(iii) Stockpiling in proper places of all materials and removal from the project site of waste and excess materials, including broken pavement and excavated debris in accordance with approved plans and specifications and contract provisions;

(iv) Deployment of committed equipment, facilities, support staff and manpower; and

(v) Renewal of the effectivity dates of the performance security after its expiration during the course of contract implementation.

© Assignment and subcontracting of the contract or any part thereof or substitution of key personnel named in the proposal without prior written approval by the procuring entity.

- (d) Poor performance by the contractor or unsatisfactory quality and/or progress of work arising from his fault or negligence as reflected in the Constructor's Performance Evaluation System ("CPES") rating sheet. In the absence of the CPES rating sheet, the existing performance monitoring system of the procuring entity shall be applied. Any of the following acts by the Contractor shall be construed as poor performance:
 - (i) Negative slippage of 15% and above within the critical path of the project due entirely to the fault or negligence of the contractor; and
 - (ii) Quality of materials and workmanship not complying with the approved specifications arising from the contractor's fault or negligence.

(31) © Willful or deliberate abandonment or non-performance of the project or contract by the contractor resulting to substantial breach thereof without lawful and/or just cause.

In addition to the penalty of suspension, the performance security posted by the contractor shall also be forfeited.

20. Force Majeure, Release from Performance

- 20.1 For purposes of this Contract the terms "*force majeure*" and "fortuitous event" may be used interchangeably. In this regard, a fortuitous event or *force majeure* shall be interpreted to mean an event which the Contractor could not have foreseen, or which though foreseen, was inevitable. It shall not include ordinary unfavorable weather conditions; and any other cause the effects of which could have been avoided with the exercise of reasonable diligence by the Contractor.
- 20.2 If this Contract is discontinued by an outbreak of war or by any other event entirely outside the control of either the Procuring Entity or the Contractor, the Procuring Entity's Representative shall certify that this Contract has been discontinued. The Contractor shall make the Site safe and stop work as quickly as possible after receiving this certificate and shall be paid for all works carried out before receiving it and for any Work carried out afterwards to which a commitment was made.
- 20.3 If the event continues for a period of eighty four (84) days, either party may then give notice of termination, which shall take effect twenty eight (28) days after the giving of the notice.
- 20.4 After termination, the Contractor shall be entitled to payment of the unpaid balance of the value of the Works executed and of the materials and Plant reasonably delivered to the Site, adjusted by the following:
 - (a) any sum to which the Contractor is entitled under **GCC** Clause 28;
 - (b) the cost of his suspension and demobilization;
 - © any sum to which the Procuring Entity is entitled.
- 20.5 The net balance due shall be paid or repaid within a reasonable time period from the time of the notice of termination.

21. Resolution of Disputes

- 21.1 If any dispute or difference of any kind whatsoever shall arise between the parties in connection with the implementation of the contract covered by the Act and this IRR,

the parties shall make every effort to resolve amicably such dispute or difference by mutual consultation.

21.2 If the Contractor believes that a decision taken by the PROCURING ENTITY's Representative was either outside the authority given to the PROCURING ENTITY's Representative by this Contract or that the decision was wrongly taken, the decision shall be referred to the Arbiter indicated in the SCC within fourteen (14) days of the notification of the PROCURING ENTITY's Representative's decision.

21.3 Any and all disputes arising from the implementation of this Contract covered by the R.A. 9184 and its IRR shall be submitted to arbitration in the Philippines according to the provisions of Republic Act No. 876, otherwise known as the " Arbitration Law" and Republic Act 9285, otherwise known as the "Alternative Dispute Resolution Act of 2004": *Provided, however*, That, disputes that are within the competence of the Construction Industry Arbitration Commission to resolve shall be referred thereto. The process of arbitration shall be incorporated as a provision in this Contract that will be executed pursuant to the provisions of the Act and its IRR: *Provided, further*, That, by mutual agreement, the parties may agree in writing to resort to other alternative modes of dispute resolution.

22. Suspension of Loan, Credit, Grant, or Appropriation

In the event that the Funding Source suspends the Loan, Credit, Grant, or Appropriation to the Procuring Entity, from which part of the payments to the Contractor are being made:

- (a) The Procuring Entity is obligated to notify the Contractor of such suspension within seven (7) days of having received the suspension notice.
- (b) If the Contractor has not received sums due it for work already done within forty five (45) days from the time the Contractor's claim for payment has been certified by the Procuring Entity's Representative, the Contractor may immediately issue a suspension of work notice in accordance with **GCC** Clause 45.2.

23. Procuring Entity's Representative's Decisions

23.1 Except where otherwise specifically stated, the Procuring Entity's Representative will decide contractual matters between the Procuring Entity and the Contractor in the role representing the Procuring Entity.

23.2 The Procuring Entity's Representative may delegate any of his duties and responsibilities to other people, except to the Arbiter, after notifying the Contractor, and may cancel any delegation after notifying the Contractor.

24. Approval of Drawings and Temporary Works by the Procuring Entity's Representative

24.1 All Drawings prepared by the Contractor for the execution of the Temporary Works, are subject to prior approval by the Procuring Entity's Representative before its use.

24.2 The Contractor shall be responsible for design of Temporary Works.

24.3 The Procuring Entity's Representative's approval shall not alter the Contractor's responsibility for design of the Temporary Works.

24.4 The Contractor shall obtain approval of third parties to the design of the Temporary Works, when required by the Procuring Entity.

25. Acceleration and Delays Ordered by the Procuring Entity's Representative

25.1 When the Procuring Entity wants the Contractor to finish before the Intended Completion Date, the Procuring Entity's Representative will obtain priced proposals for

achieving the necessary acceleration from the Contractor. If the Procuring Entity accepts these proposals, the Intended Completion Date will be adjusted accordingly and confirmed by both the Procuring Entity and the Contractor.

- 25.2 If the Contractor's Financial Proposals for an acceleration are accepted by the Procuring Entity, they are incorporated in the Contract Price and treated as a Variation.

26. Extension of the Intended Completion Date

26.1 The Procuring Entity's Representative shall extend the Intended Completion Date if a Variation is issued which makes it impossible for the Intended Completion Date to be achieved by the Contractor without taking steps to accelerate the remaining work, which would cause the Contractor to incur additional costs. No payment shall be made for any event which may warrant the extension of the Intended Completion Date.

26.2 The Procuring Entity's Representative shall decide whether and by how much to extend the Intended Completion Date within twenty one (21) days of the Contractor asking the Procuring Entity's Representative for a decision thereto after fully submitting all supporting information. If the Contractor has failed to give early warning of a delay or has failed to cooperate in dealing with a delay, the delay by this failure shall not be considered in assessing the new Intended Completion Date.

27. Right to Vary

27.1 The Procuring Entity's Representative with the prior approval of the Procuring Entity may instruct Variations, up to a maximum cumulative amount of ten percent (10%) of the original contract cost.

27.2 Variations shall be valued as follows:

- (a) At a lump sum price agreed between the parties;
- (b) where appropriate, at rates in this Contract;
- © in the absence of appropriate rates, the rates in this Contract shall be used as the basis for valuation; or failing which
- (d) at appropriate new rates, equal to or lower than current industry rates and to be agreed upon by both parties and approved by the Head of the Procuring Entity.

28. Contractor's Right to Claim

If the Contractor incurs cost as a result of any of the events under **GCC** Clause 13, the Contractor shall be entitled to the amount of such cost. If as a result of any of the said events, it is necessary to change the Works, this shall be dealt with as a Variation.

29. Dayworks

29.1 Subject to **GCC** Clause 43 on Variation Order, and if applicable as indicated in the SCC, the Dayworks rates in the Contractor's Bid shall be used for small additional amounts of work only when the Procuring Entity's Representative has given written instructions in advance for additional work to be paid for in that way.

29.2 All work to be paid for as Dayworks shall be recorded by the Contractor on forms approved by the Procuring Entity's Representative. Each completed form shall be verified and signed by the Procuring Entity's Representative within two days of the work being done.

29.3 The Contractor shall be paid for Dayworks subject to obtaining signed Dayworks forms.

30. Early Warning

- 30.1 The Contractor shall warn the Procuring Entity's Representative at the earliest opportunity of specific likely future events or circumstances that may adversely affect the quality of the work, increase the Contract Price, or delay the execution of the Works. The Procuring Entity's Representative may require the Contractor to provide an estimate of the expected effect of the future event or circumstance on the Contract Price and Completion Date. The estimate shall be provided by the Contractor as soon as reasonably possible.
- 30.2 The Contractor shall cooperate with the Procuring Entity's Representative in making and considering proposals for how the effect of such an event or circumstance can be avoided or reduced by anyone involved in the work and in carrying out any resulting instruction of the Procuring Entity's Representative.

31. Program of Work

- 31.1 Within the time stated in the SCC, the Contractor shall submit to the Procuring Entity's Representative for approval a Program of Work showing the general methods, arrangements, order, and timing for all the activities in the Works.
- 31.2 An update of the Program of Work shall show the actual progress achieved on each activity and the effect of the progress achieved on the timing of the remaining work, including any changes to the sequence of the activities.
- 31.3 The Contractor shall submit to the Procuring Entity's Representative for approval an updated Program of Work at intervals no longer than the period stated in the SCC. If the Contractor does not submit an updated Program of Work within this period, the PROCURING ENTITY's Representative may withhold the amount stated in the SCC from the next payment certificate and continue to withhold this amount until the next payment after the date on which the overdue Program of Work has been submitted.
- 31.4 The Procuring Entity's Representative's approval of the Program of Work shall not alter the Contractor's obligations. The Contractor may revise the Program of Work and submit it to the Procuring Entity's Representative again at any time. A revised Program of Work shall show the effect of any approved Variations.
- 31.5 When the Program of Work is updated, the Contractor shall provide the Procuring Entity's Representative with an updated cash flow forecast. The cash flow forecast shall include different currencies, as defined in the Contract, converted as necessary using the Contract exchange rates.
- 31.6 All Variations shall be included in updated Program of Work produced by the Contractor.

32. Management Conferences

- 32.1 Either the Procuring Entity's Representative or the Contractor may require the other to attend a Management Conference. The Management Conference shall review the plans for remaining work and deal with matters raised in accordance with the early warning procedure.
- 32.2 The Procuring Entity's Representative shall record the business of Management Conferences and provide copies of the record to those attending the Conference and to the Procuring Entity. The responsibility of the parties for actions to be taken shall be decided by the PROCURING ENTITY's Representative either at the Management Conference or after the Management Conference and stated in writing to all who attended the Conference.

33. Bill of Quantities

- 33.1 The Bill of Quantities shall contain items of work for the construction, installation, testing, and commissioning of work to be done by the Contractor.
- 33.2 The Bill of Quantities is used to calculate the Contract Price. The Contractor is paid for the quantity of the work done at the rate in the Bill of Quantities for each item.
- 33.3 If the final quantity of any work done differs from the quantity in the Bill of Quantities for the particular item and is not more than twenty five percent (25%) of the original quantity, provided the aggregate changes for all items do not exceed ten percent (10%) of the Contract price, the Procuring Entity's Representative shall make the necessary adjustments to allow for the changes subject to applicable laws, rules, and regulations.
- 33.4 If requested by the Procuring Entity's Representative, the Contractor shall provide the Procuring Entity's Representative with a detailed cost breakdown of any rate in the Bill of Quantities.

34. Instructions, Inspections and Audits

- 34.1 The Procuring Entity's personnel shall at all reasonable times during construction of the Work be entitled to examine, inspect, measure and test the materials and workmanship, and to check the progress of the construction.
- 34.2 If the Procuring Entity's Representative instructs the Contractor to carry out a test not specified in the Specification to check whether any work has a defect and the test shows that it does, the Contractor shall pay for the test and any samples. If there is no defect, the test shall be a Compensation Event.
- 34.3 The Contractor shall permit the Funding Source named in the SCC to inspect the Contractor's accounts and records relating to the performance of the Contractor and to have them audited by auditors appointed by the Funding Source, if so required by the Funding Source.

35. Identifying Defects

The Procuring Entity's Representative shall check the Contractor's work and notify the Contractor of any defects that are found. Such checking shall not affect the Contractor's responsibilities. The Procuring Entity's Representative may instruct the Contractor to search uncover defects and test any work that the Procuring Entity's Representative considers below standards and defective.

36. Cost of Repairs

Loss or damage to the Works or Materials to be incorporated in the Works between the Start Date and the end of the Defects Liability Periods shall be remedied by the Contractor at the Contractor's cost if the loss or damage arises from the Contractor's acts or omissions.

37. Correction of Defects

- 37.1 The Procuring Entity's Representative shall give notice to the Contractor of any defects before the end of the Defects Liability Period, which is One (1) year from project completion up to final acceptance by the Procuring Entity's.
- 37.2 Every time notice of a defect is given, the Contractor shall correct the notified defect within the length of time specified in the Procuring Entity's Representative's notice.
- 37.3 The Contractor shall correct the defects which he notices himself before the end of the Defects Liability Period.

- 37.4 The Procuring Entity shall certify that all defects have been corrected. If the Procuring Entity considers that correction of a defect is not essential, he can request the Contractor to submit a quotation for the corresponding reduction in the Contract Price. If the Procuring Entity accepts the quotation, the corresponding change in the SCC is a Variation.

38. Uncorrected Defects

- 38.1 The Procuring Entity shall give the Contractor at least fourteen (14) days notice of his intention to use a third party to correct a Defect. If the Contractor does not correct the Defect himself within the period, the Procuring Entity may have the Defect corrected by the third party. The cost of the correction will be deducted from the Contract Price.
- 38.2 The use of a third party to correct defects that are uncorrected by the Contractor will in no way relieve the Contractor of its liabilities and warranties under the Contract.

39. Advance Payment

- 39.1 The Procuring Entity shall, upon a written request of the contractor which shall be submitted as a contract document, make an advance payment to the contractor in an amount not exceeding fifteen percent (15%) of the total contract price, to be made in lump sum or, at the most two, installments according to a schedule specified in the SCC.
- 39.2 The advance payment shall be made only upon the submission to and acceptance by the Procuring Entity of an irrevocable standby letter of credit of equivalent value from a commercial bank, a bank guarantee or a surety bond callable upon demand, issued by a surety or insurance company duly licensed by the Insurance Commission and confirmed by the Procuring Entity.
- 39.3 The advance payment shall be repaid by the Contractor by an amount equal to the percentage of the total contract price used for the advance payment.
- 39.4 The contractor may reduce his standby letter of credit or guarantee instrument by the amounts refunded by the Monthly Certificates in the advance payment.
- 39.5 The Procuring Entity will provide an Advance Payment on the Contract Price as stipulated in the Conditions of Contract, subject to the maximum amount stated in SCC Clause 39.1.

40. Progress Payments

- 40.1 The Contractor may submit a request for payment for Work accomplished. Such request for payment shall be verified and certified by the Procuring Entity's Representative/Project Engineer. Except as otherwise stipulated in the SCC, materials and equipment delivered on the site but not completely put in place shall not be included for payment.
- 40.2 The Procuring Entity shall deduct the following from the certified gross amounts to be paid to the contractor as progress payment:
- (a) Cumulative value of the work previously certified and paid for.
 - (b) Portion of the advance payment to be recouped for the month.
 - © Retention money in accordance with the condition of contract.

(31) Amount to cover third party liabilities.

- © Amount to cover uncorrected discovered defects in the works.

- 40.3 Payments shall be adjusted by deducting therefrom the amounts for advance payments and retention. The Procuring Entity shall pay the Contractor the amounts certified by the Procuring Entity's Representative within twenty eight (28) days from the date each certificate was issued. No payment of interest for delayed payments and adjustments shall be made by the Procuring Entity.
- 40.4 The first progress payment may be paid by the Procuring Entity to the Contractor provided that at least twenty percent (20%) of the work has been accomplished as certified by the Procuring Entity's Representative.
- 40.5 Items of the Works for which a price of "0" (zero) has been entered will not be paid for by the Procuring Entity and shall be deemed covered by other rates and prices in the Contract.

41. Payment Certificates

- 41.1 The Contractor shall submit to the Procuring Entity's Representative monthly statements of the estimated value of the work executed less the cumulative amount certified previously.
- 41.2 The Procuring Entity's Representative shall check the Contractor's monthly statement and certify the amount to be paid to the Contractor.
- 41.3 The value of Work executed shall:
- (a) be determined by the Procuring Entity's Representative;
 - (b) comprise the value of the quantities of the items in the Bill of Quantities completed; and
 - © include the valuations of approved variations.
- 41.4 The Procuring Entity's Representative may exclude any item certified in a previous certificate or reduce the proportion of any item previously certified in any certificate in the light of later information.

42. Retention

- 42.1 The Procuring Entity shall retain from each payment due to the Contractor an amount equal to a percentage thereof using the rate as specified in **ITB** Sub-Clause 42.2.
- 42.2 Progress payments are subject to retention of ten percent (10%), referred to as the "retention money." Such retention shall be based on the total amount due to the Contractor prior to any deduction and shall be retained from every progress payment until fifty percent (50%) of the value of Works, as determined by the Procuring Entity, are completed. If, after fifty percent (50%) completion, the Work is satisfactorily done and on schedule, no additional retention shall be made; otherwise, the ten percent (10%) retention shall again be imposed using the rate specified therefor.
- 42.3 The total "retention money" shall be due for release upon final acceptance of the Works. The Contractor may, however, request the substitution of the retention money for each progress billing with irrevocable standby letters of credit from a commercial bank, bank guarantees or surety bonds callable on demand, of amounts equivalent to the retention money substituted for and acceptable to the Procuring Entity, provided that the project is on schedule and is satisfactorily undertaken. Otherwise, the ten (10%) percent retention shall be made. Said irrevocable standby letters of credit, bank guarantees and/or surety bonds, to be posted in favor of the Government shall be valid for a duration to be determined by the concerned implementing office/agency or Procuring Entity and will answer for the purpose for which the ten (10%) percent retention is intended, *i.e.*, to cover uncorrected discovered defects and third party liabilities.

- 42.4 On completion of the whole Works, the Contractor may substitute retention money with an “on demand” Bank guarantee in a form acceptable to the Procuring Entity.

43. Variation Orders

- 43.1 Variation Orders may be issued by the Procuring Entity to cover any increase/decrease in quantities, including the introduction of new work items that are not included in the original contract or reclassification of work items that are either due to change of plans, design or alignment to suit actual field conditions resulting in disparity between the preconstruction plans used for purposes of bidding and the “as staked plans” or construction drawings prepared after a joint survey by the Contractor and the Procuring Entity after award of the contract, provided that the cumulative amount of the Variation Order does not exceed ten percent (10%) of the original project cost. The addition/deletion of Works should be within the general scope of the project as bid and awarded. The scope of works shall not be reduced so as to accommodate a positive Variation Order. A Variation Order may either be in the form of a Change Order or Extra Work Order.
- 43.2 A Change Order may be issued by the Procuring Entity to cover any increase/decrease in quantities of original Work items in the contract.
- 43.3 An Extra Work Order may be issued by the Procuring Entity to cover the introduction of new work necessary for the completion, improvement or protection of the project which were not included as items of Work in the original contract, such as, where there are subsurface or latent physical conditions at the site differing materially from those indicated in the contract, or where there are duly unknown physical conditions at the site of an unusual nature differing materially from those ordinarily encountered and generally recognized as inherent in the Work or character provided for in the contract.
- 43.4 Any cumulative Variation Order beyond ten percent (10%) shall be subject of another contract to be bid out if the works are separable from the original contract. In exceptional cases where it is urgently necessary to complete the original scope of work, the Head of the Procuring Entity may authorize a positive Variation Order go beyond ten percent (10%) but not more than twenty percent (20%) of the original contract price, subject to the guidelines to be determined by the GPPB: *Provided, however,* That appropriate sanctions shall be imposed on the designer, consultant or official responsible for the original detailed engineering design which failed to consider the Variation Order beyond ten percent (10%).
- 43.5 In claiming for any Variation Order, the Contractor shall, within seven (7) calendar days after such work has been commenced or after the circumstances leading to such condition(s) leading to the extra cost, and within twenty-eight (28) calendar days deliver a written communication giving full and detailed particulars of any extra cost in order that it may be investigated at that time. Failure to provide either of such notices in the time stipulated shall constitute a waiver by the contractor for any claim. The preparation and submission of Variation Orders are as follows:
- (a) If the Procuring Entity’s representative/Project Engineer believes that a Change Order or Extra Work Order should be issued, he shall prepare the proposed Order accompanied with the notices submitted by the Contractor, the plans therefore, his computations as to the quantities of the additional works involved per item indicating the specific stations where such works are needed, the date of his inspections and investigations thereon, and the log book thereof, and a detailed estimate of the unit cost of such items of work, together with his justifications for the need of such Change Order or Extra Work Order, and shall submit the same to the Head of the Procuring Entity for approval.
 - (b) The Head of the Procuring Entity or his duly authorized representative, upon receipt of the proposed Change Order or Extra Work Order shall immediately instruct the technical staff of the Procuring Entity’s to conduct an on-the-spot

investigation to verify the need for the Work to be prosecuted. A report of such verification shall be submitted directly to the Head of the Procuring Entity or his duly authorized representative.

- © The, Head of the Procuring Entity or his duly authorized representative, after being satisfied that such Change Order or Extra Work Order is justified and necessary, shall review the estimated quantities and prices and forward the proposal with the supporting documentation to the Head of Procuring Entity for consideration.

(31) If, after review of the plans, quantities and estimated unit cost of the items of work involved, the proper office of the procuring entity empowered to review and evaluate Change Orders or Extra Work Orders recommends approval thereof, Head of the Procuring Entity or his duly authorized representative, believing the Change Order or Extra Work Order to be in order, shall approve the same.

- © The timeframe for the processing of Variation Orders from the preparation up to the approval by the Head of the Procuring Entity concerned shall not exceed thirty (30) calendar days.

44. Contract Completion

Once the project reaches an accomplishment of ninety five (95%) of the total contract amount, the Procuring Entity may create an inspectorate team to make preliminary inspection and submit a punch-list to the Contractor in preparation for the final turnover of the project. Said punch-list will contain, among others, the remaining Works, Work deficiencies for necessary corrections, and the specific duration/time to fully complete the project considering the approved remaining contract time. This, however, shall not preclude the claim of the Procuring Entity for liquidated damages.

45. Suspension of Work

45.1 The Procuring Entity shall have the authority to suspend the work wholly or partly by written order for such period as may be deemed necessary, due to *force majeure* or any fortuitous events or for failure on the part of the Contractor to correct bad conditions which are unsafe for workers or for the general public, to carry out valid orders given by the Procuring Entity or to perform any provisions of the contract, or due to adjustment of plans to suit field conditions as found necessary during construction. The Contractor shall immediately comply with such order to suspend the work wholly or partly.

45.2 The Contractor or its duly authorized representative shall have the right to suspend work operation on any or all projects/activities along the critical path of activities after fifteen (15) calendar days from date of receipt of written notice from the Contractor to the district engineer/regional director/consultant or equivalent official, as the case may be, due to the following:

- (a) There exist right-of-way problems which prohibit the Contractor from performing work in accordance with the approved construction schedule.
- (b) Requisite construction plans which must be owner-furnished are not issued to the contractor precluding any work called for by such plans.
- © Peace and order conditions make it extremely dangerous, if not possible, to work. However, this condition must be certified in writing by the Philippine National Police (PNP) station which has responsibility over the affected area and confirmed by the Department of Interior and Local Government (DILG) Regional Director.

(31) There is failure on the part of the Procuring Entity to deliver government-furnished materials and equipment as stipulated in the contract.

- © Delay in the payment of Contractor's claim for progress billing beyond forty-five (45) calendar days from the time the Contractor's claim has been certified to by the procuring entity's authorized representative that the documents are complete unless there are justifiable reasons thereof which shall be communicated in writing to the Contractor.

45.3 In case of total suspension, or suspension of activities along the critical path, which is not due to any fault of the Contractor, the elapsed time between the effective order of suspending operation and the order to resume work shall be allowed the Contractor by adjusting the contract time accordingly.

46. Payment on Termination

46.1 If the Contract is terminated because of a fundamental breach of Contract by the Contractor, the Procuring Entity's Representative shall issue a certificate for the value of the work done and Materials ordered less advance payments received up to the date of the issue of the certificate and less the percentage to apply to the value of the work not completed, as indicated in the SCC. Additional Liquidated Damages shall not apply. If the total amount due to the Procuring Entity exceeds any payment due to the Contractor, the difference shall be a debt payable to the Procuring Entity.

46.2 If the Contract is terminated for the Procuring Entity's convenience or because of a fundamental breach of Contract by the Procuring Entity, the Procuring Entity's Representative shall issue a certificate for the value of the work done, Materials ordered, the reasonable cost of removal of Equipment, repatriation of the Contractor's personnel employed solely on the Works, and the Contractor's costs of protecting and securing the Works, and less advance payments received up to the date of the certificate.

46.3 The net balance due shall be paid or repaid within twenty eight (28) days from the notice of termination.

46.4 If the Contractor has terminated the Contract under **GCC** Clauses 17 and 18, the Procuring Entity shall promptly return the Performance Security to the Contractor.

47. Extension of Contract Time

47.1 Should the amount of additional work of any kind or other special circumstances of any kind whatsoever occur such as to fairly entitle the contractor to an extension of contract time, the Procuring Entity shall determine the amount of such extension; provided that the Procuring Entity is not bound to take into account any claim for an extension of time unless the Contractor has, prior to the expiration of the contract time and within thirty (30) calendar days after such work has been commenced or after the circumstances leading to such claim have arisen, delivered to the Procuring Entity notices in order that it could have investigated them at that time. Failure to provide such notice shall constitute a waiver by the Contractor of any claim. Upon receipt of full and detailed particulars, the Procuring Entity shall examine the facts and extent of the delay and shall extend the contract time completing the contract work when, in the Procuring Entity's opinion, the findings of facts justify an extension.

47.2 No extension of contract time shall be granted the Contractor due to (a) ordinary unfavorable weather conditions and (b) inexcusable failure or negligence of Contractor to provide the required equipment, supplies or materials.

47.3 Extension of contract time may be granted only when the affected activities fall within the critical path of the PERT/CPM network.

- 47.4 No extension of contract time shall be granted when the reason given to support the request for extension was already considered in the determination of the original contract time during the conduct of detailed engineering and in the preparation of the contract documents as agreed upon by the parties before contract perfection.
- 47.5 Extension of contract time shall be granted for rainy/unworkable days considered unfavorable for the prosecution of the works at the site, based on the actual conditions obtained at the site, in excess of the number of rainy/unworkable days pre-determined by the Procuring Entity in relation to the original contract time during the conduct of detailed engineering and in the preparation of the contract documents as agreed upon by the parties before contract perfection, and/or for equivalent period of delay due to major calamities such as exceptionally destructive typhoons, floods and earthquakes, and epidemics, and for causes such as non-delivery on time of materials, working drawings, or written information to be furnished by the Procuring Entity, non-acquisition of permit to enter private properties within the right-of-way resulting in complete paralyzation of construction activities, and other meritorious causes as determined by the Procuring Entity's Representative and approved by the Head of the Procuring Entity. Shortage of construction materials, general labor strikes, and peace and order problems that disrupt construction operations through no fault of the Contractor may be considered as additional grounds for extension of contract time provided they are publicly felt and certified by appropriate government agencies such as DTI, DOLE, DILG, and DND, among others. The written consent of bondsmen must be attached to any request of the Contractor for extension of contract time and submitted to the Procuring Entity for consideration and the validity of the Performance Security shall be correspondingly extended.

48. Price Adjustment

Except for extraordinary circumstances as determined by NEDA and approved by the GPPB, no price adjustment shall be allowed. Nevertheless, in cases where the cost of the awarded contract is affected by any applicable new laws, ordinances, regulations, or other acts of the GOP, promulgated after the date of bid opening, a contract price adjustment shall be made or appropriate relief shall be applied on a no loss-no gain basis.

49. Completion

The Contractor shall request the Procuring Entity's Representative to issue a certificate of Completion of the Works, and the Procuring Entity's Representative will do so upon deciding that the work is completed.

50. Taking Over

The Procuring Entity shall take over the Site and the Works within seven (7) days from the date the Procuring Entity's Representative issues a certificate of Completion.

51. Operating and Maintenance Manuals

- 51.1 If "as built" Drawings and/or operating and maintenance manuals are required, the Contractor shall supply them by the dates stated in the SCC.
- 51.2 If the Contractor does not supply the Drawings and/or manuals by the dates stated in the SCC, or they do not receive the Procuring Entity's Representative's approval, the Procuring Entity's Representative shall withhold the amount stated in the SCC from payments due to the Contractor.

SPECIAL CONDITIONS OF CONTRACT (SCC)

Name of Project:

RENOVATION OF HEALTH SERVICES UNIT (ITB-2024-008)

GCC Clause	
1.16	The intended Completion date for the following is: 63 Calendar Days To commence three (3) calendar days from receipt of the Notice to Proceed
1.21	The PROCURING ENTITY is: UNIVERSITY OF THE PHILIPPINES VISAYAS Miag-ao, Iloilo
1.22	The University's Representative: Engr. Mario M. Morano Chief, CDMO U.P. Visayas, Miagao, Iloilo Tel. No. (033) 315-98-01 / 513-87-72
1.23	UP Visayas, Miag-ao Iloilo Campus
1.27	The start date is: Three (3) calendar days from receipt of the Notice to Proceed
1.30	The works for all projects are defined in the Terms of Reference of the Bidding Documents
2.2	Completion of works are as follows: 63 Calendar Days
5.1	Possession of site: The University shall give possession of all the sites to the contractor for the period specified for each project to commence three (3) calendar days from receipt of the Notice to Proceed.
6.5	The contractor shall employ their own Key Personnel indicating their names and designations.
7.4 ©	The performance security shall be discharged by the University and returned to the contractor upon termination of the contract provided no claim have been filed against the contractor for violation of any of the terms and conditions of the Agreement and to be released within thirty (30) days from date of receipt of the letter of refund from the contractor.
8.1	Sub Contract is not allowed.
21.2	The Arbiter is to be designated by the University
29.1	Dayworks are applicable at the rate shown in the Contractor's original bid
31.1& 31.3	The contractor shall submit Program of Works to the University's Engineer within three (3) calendar days from the issue of the billing.



UNIVERSITY OF THE PHILIPPINES VISAYAS
BIDS AND AWARDS COMMITTEE

Miagao, Iloilo, Philippines 5023
Tel Nos. (033) 3159631-32 local 181 / 247 (033) 3159858 / (033) 315 8141
email: upvbac@yahoo.com

Scope of Works

Scope of Works:

1 General Requirements

1.a. Temporary Facilities

Contractor shall furnish, install and maintain temporary facilities required for construction for the duration of the project, and remove upon completion of the work as specified herein

1.b. Safety and Health

The contractor shall ensure the protection and welfare of workers and the general public within and around the construction site taking into consideration industry practices and applicable government requirements

1.c. Electricity and Water Consumption

The contractor shall provide electricity and water for the entire duration of the project

1.d. Mobilization and Demobilization

The work consists of the mobilization and demobilization of the contractor's forces and equipment necessary for performing the work required under the contract.

2 Site Preparation

3 Renovation of Laboratories

3.a. Transfer of Tables, Equipments, Etc.

3.b. Demolition of Existing Walls, Chipping, Hauling of Debris

3.c. Covering of Existing Doors and Window Openings

3.d. Installation of Partitions and Concave Floor to Wall Connection

3.e. Installation of Counters with Sink

3.f. Installation of Doors

3.g. Ceiling Works

3.h. Painting Works

3.i. Electrical Works

Provide and installation of Elect'l. panel boards and protection/circuit breakers.

Installation of pull boxes, outlets, switches and lighting devices.

Provide and connection of circuit lines and grounding system.

Provide/installation of all boxes, connectors, pipes etc.

Provide and connection of circuit lines and wirings

Pull-out Existing Outlets, Lightings, pipes and other cables

3.j. Plumbing Works including STP

3.k. Tiling Works

4 Extension of Hallway

4.a. Excavation

4.b. Rebar, Concrete and Form Works (Including Parapet Wall and Railings)

4.c. Painting Works

SPECIFICATIONS:

CONCRETE AND REINFORCED CONCRETE

A. Furnish labor materials, equipment to complete the work as indicated herein or in the working drawings and or the scope of work.

B. Unless otherwise indicated on the drawing or specified herein, undertake all concrete work in accordance with "Specifications for Concrete and Reinforced Concrete" as adopted by the Department of Public Works and Highways (DPWH).

C. Materials:

Cement: Use Portland Cement conforming to and in accordance with the "Standard Specifications for Portland Cement".

Fine Aggregates: Use well graded, washed sand having clean, hard, durable, uncoated particles free from injurious amounts of dust, lumps of soft clay and flaky particles, shells, alkali organic matter, loam and other deleterious materials. Maximum diameter: 1/4 - 1"Ø.

Water: Clean, fresh and potable water.

Reinforcing Bars: Use sizes as indicated in the drawings, $F_y = 420$ Mpa, grade 60 for 16mm reinforcing steel bar up

Ties: For reinforcing bars, use No. 16 GI wires.

D. Concrete Mixes:

1. Use class "A" concrete (1:2:4)/3,000psi for footings tie beams, lintel beams and columns
2. Use class "B" concrete (1:3) for masonry filler.

E. Concrete Placement

In placing concrete, use bucket or buggy to transport. Place concrete not over 0.60 meters deep; compact each layer thoroughly mechanically or manually. Do not use vibrators to transport concrete inside the forms and limit vibration duration to time necessary to produce satisfactory consolidation without causing objectionable segregation of aggregates.

F. For partitions use Expanded Polystyrene Panel (2"x4'x10') with wire mesh.

Dowels: Use 10mm x 600mm in length embedded at 300mm interval on both side of the panel on an alternate positions

Use Flat Mesh for connection between two panels.

Use Angle Mesh for additional reinforcing connectors in all corners of the panel structure.

Use U-Mesh for additional reinforcing connectors used in all borders of windows/door openings for extra strength and holder for jambs/frames.

Use GI # 18 for all connections to provide extra strength and prevent the plaster from cracking.

G. Concrete Finishes:

-Clean and wash down all that are to receive plaster for reinforced concrete walls, columns and lintel beams, remove surface 1/16" deep, expose aggregates then wash down and leave clean, firm, rough granular surface.

- Apply coats of cement plaster.

Scratch coat, one part cement, three parts fine sand, finish coat not less than 6mm and max. of 16mm

- After setting, keep finish coat surface damp for seven days.

ROOF AND ROOF FRAMING WORKS

- Furnish labor, materials and equipment to complete the work as indicated in the plan or specified herein or both. All soldered joints must be scrubbed hard with stiff steel brush, washdown with water and remove acidic soldered flux. Apply rust converter prior to application of primeguard metal primer (1 coat)

- Top and Bottom Chord: use 2"x2"x1/4" Angle Bar, Web Member: use 1 1/2"x1 1/2"x1/4" Angle Bar
- Purlins: use 1.20mm thk. x 2" x 2" LGC (C-Purlins).
- Roofing: use 0.50mm thk Rib Type longspan prepainted roofing sheets.
- Facia/wall Flashing: use 0.60mm thk x 24" Standard Type Pre-painted.

PAINTING WORK

Work includes complete painting of walls (inner & outer surface), columns, doors and windows.

For all masonry and concrete surfaces, semigloss/flatwall latex paint shall be used.

Use products and materials only in accordance with manufacturer's instructions

Color scheme shall be as directed by the engineer or the end user.

Ceiling Works

Ceiling board: 3.50mm x 4' x 8' Ficem Board with 3 coats of flat latex paint.

For ceiling metal frames use:

0.600mm thck x 25mm x 25mm Wall Angle

0.600mm thck x 19mm x 50mm J-Furring space at 0.40m both ways

1.0mm x 12mm x 38mm Carrying Channel at 1.20m on center

Use W-Clip

DOORS & WINDOWS

- Please refer to approved plan and estimate

PLUMBING INSTALLATION

Work includes furnishing of necessary materials, labor and tools for the installation of all plumbing fixtures and piping system. Work will only be done by skilled/certified plumber with supervision of at least master plumber. Install fixture and pipelines as shown in the working drawing.

Materials|

- For Semi Countertop lavatory, use American Standard, White complete with accessories present samples for approval.
- For wall hung lavatory, use American Standard, White complete with accessories present samples for approval.
- For water lines use PPR pipes and fittings with sizes (inside diameter) as indicated in the approved plan.
- Soil/drain pipes shall be PVC series 1000 with sizes as indicated in the approved plan and shall be connected/directed to the nearest septic tank.
- Before turn over, water tightness test shall be conducted.
- All pipes located in the ground shall be buried at least 0.30m.

Electrical Works

Nature of service shall be 230 Volts 1-Phase, 60Hz, Line to Line connection.

Use only materials that are new and high quality, with PS markings.

Use 2C - 38sq. mm THW Cu. Wire and 1C- 8.0 sq. mm THW Cu. Wire as ground wire.

Use minimum of 8.0 sq. mm THW cu. Wire (Green) as ground and connected to the grounding rod provided

Use 125 Amps. CB, 2P, 25 KAIC @ 240V, Bolt-on, industrial type with fourteen (14) protection branches Square-d or approved equal quality.

All ACU outlets must be 3-wire connection using 2C-5.5 sq.mm THHN and 1C-3.5 sq.mm THHN Cu. Wire (green).

All outlets must be 3-wire connection, using 2C- 3.5 sq.mm. THHN and 1C- 3.5 sq. mm THHN Cu wire green(grounding).

Minimum size of wire to be use as line/live wire must be 3.5 sq. mm. THHN Cu. Wire.

Use 5/8" x 10f t pure copper ground rod with two-bolt type connector, burndy to installed ground

Use 18 watts LED linear lamp, T8, 240V, daylight, one-end supply into louver type lighting fixtures

Use 9 watts LED linear lamp, T8, 240V, daylight, one-end supply into louver type lighting fixtures

Use 6" Vertical Downlight pinlight fixture w/ 9 watts LED, E27, 240V, daylight,

Use Universal Duplex Convenience Outlet, 3-pronge w/ ground, wide series, flush type, panasonic or approve equal quality.

Use wide series switches, panasonic, flush type or approve equal quality to control each lightings.

Use and install 30Amps. 2P, KSB for ACU outside the building.

All outlets and breakers should be tap to the grounding system.

Use only thick wall type, uPVC Electrical Pipe, Atlanta; Flexible hose/pipe are not accepted.

All conduits are thickwall upvc or unless otherwise specified as indicated in the schedule of loads and riser diagram. Conduits shall be protected against damages from foreign matter and entrance of water

during construction. All ends of conduits shall be properly plugged to exclude moisture and dust immediately after installed.

Mounting heights of devices should be as approved by the designers (architect & electrical) as follows:

panelboards -----1.82 mtrs aboved finished floor to top of panel

wall switches -----1.37 mtrs aboved finished floor to center of device

convenience -----0.5 mtr aboved finished floor to center of device, or

0.15 mtr aboved working counter to center

All circuit lines and wiring shall be concealed on ceilings, walls and partition.

All junction box, pull boxes and hand-hole should be covered.

All connections should be made with a required boxes and using solderless connector.

All boxes connected with uPVC pipe should be provided with uPVC adaptor and locknut.

All Pull out existing materials and fixtures should be turn over to CDMO.

All works shall be done in good workmanship and be place in proper places with the guidance of
CDMO Engineers.

All works shall be done in accordance with the latest edition of Philippine Electrical Code.

All works shall be done under direct supervision of a duly license Electrical Engineer or Registered Master Electrician.

OTHER SPECIFICATIONS (as stated in the estimate and approved plans)

Other specifications to be used shall conform to the approved estimates and plans.

- All works shall be done in good workmanship and be place in proper places

with the guidance of CDMO Engineers.

All Pull out existing materials and fixtures should be turn over to CDMO.



**UNIVERSITY OF THE PHILIPPINES VISAYAS
BIDS AND AWARDS COMMITTEE**

Name of Project:

“RENOVATION OF HEALTH SERVICES UNIT (ITB-2024-008)”

CHECKLIST OF ELIGIBILITY REQUIREMENTS

i)	PhilGEPS Certificate of Registration (Platinum Membership) with attached Annex “A” Annex A attachments must be complete and valid
ii)	Valid Philippine Contractors Accreditation Board (PCAB) License or Special PCAB License in case of Joint Ventures, and registration for the type and cost of the contract to be bid
iii)	Statement of the prospective bidder of all its ongoing government and private contracts, including contracts awarded but not yet started, if any, whether similar or not similar in nature and complexity to the contract to be bid.
iv)	Statement of the bidder’s Single Largest Completed Contract (SLCC) similar to the contract to be bid, except under conditions provided for in Sections 23.4.1.3 and 23.4.2.4 of this IRR, within the relevant period as provided in the Bidding Documents in the case of Goods. All of the above statements shall include all information required in the BDs prescribed by the GPPB
v)	The prospective bidder’s computation of Net Financial Contracting Capacity (NFCC). (see page 62). The computation and formula must be correct and shown.
vi)	If applicable a Valid Joint Venture Agreement Joint Venture bidders shall submit a Joint Venture Agreement in accordance with R.A. 4566 and its IRR. Each partner of the joint venture shall submit their respective PhilGEPS Certificates of Registration in accordance with Section 8.5.2 of IRR. The submission of technical and financial eligibility documents by any of the joint venture partners constitutes compliance: Provided, That the partner responsible to submit the NFCC shall likewise submit the Statement of all of its ongoing contracts and Audited Financial Statements.
vii)	Questionnaire for prospective bidders (duly accomplished and notarized)

Note: Any missing document in the above-mentioned checklist is a ground for outright rejection of the b



**UNIVERSITY OF THE PHILIPPINES VISAYAS
BIDS AND AWARDS COMMITTEE**

Name of Project:

“RENOVATION OF HEALTH SERVICES UNIT (ITB-2024-008)”

CHECKLIST OF TECHNICAL REQUIREMENTS

The Technical Component shall contain the following:

1.	Bid Security in the prescribed form, amount and validity period
2.	Authority of the Signatory The signatory is the duly authorized representative of the prospective bidder, and granted full power and authority to do, execute and perform any and all acts necessary and/or to represent the prospective bidder in the bidding, with the duly notarized Secretary's certificate attesting to such fact, if the prospective bidder is a corporation, cooperative, or a joint venture If the person attending the bidding is not the signatory, an authorization for the concerned person to attend the bidding must be executed by the prospective bidder and should be included in the bidding documents submitted. The Authorization must indicate the name of the project.
3.	Duly signed Construction Schedule and S-Curve
4.	Duly signed Manpower Schedule
5.	Duly signed Construction Methods in Narrative Form
6.	Duly signed Contract Organizational Chart
7.	Duly signed List of Contractor's Key Personnel to be assigned to the contract to be bid, with their complete qualification, experience data, PRC License, etc.
8.	Duly signed List of Contractor's Equipment (owned, leased, or under purchase agreement)
9.	Duly signed Equipment Utilization Schedule
10.	Certificate of Site Inspection duly signed by the UPV Representative (Chief, CDMO) or its or its duly authorized representative Only Licensed Arch. or Engineer will conduct Site Inspection. For this purpose presentation of PRC ID is required. Site inspection will be on (To be discussed during pre-bidding conference.).
11.	Duly signed Construction Safety and Health Program
12.	Omnibus Sworn Statement

Note: Any missing document in the above mentioned checklist is a ground for outright rejection of the bid.

**Statement identifying the Bidder's Single Largest Completed Contract similar in nature
within the relevant period of **FIVE (5) years****

Contract to be Bid : _____
 Business Name : _____
 Business Address: _____

Name of Client	a. Owner's Name b. Address c. Telephone Nos.	Title of the Project in the Contract	Nature of Work	a. Date Awarded b. Contract Effectivity c. Date Completed	Contractor's Role (whether sole contractor, subcontractor, or partner in a JV)		a. Total Contract Value at Award b. Total Contract Value at Completion c. Contract Duration
					Description	%	
<u>Government</u>							
<u>Private</u>							

- Note: This statement shall be supported with:
1. Notice of Award and/or Contract
 2. Notice to Proceed issued by the Owner
 3. Owner's Certificate of Final Acceptance or Certificate of Completion
 4. Constructors Performance Evaluation Summary (CPES) Final Rating, which must be satisfactory, if applicable

Submitted by : _____
 (Print Name and Signature)
 Designation : _____
 Date : _____

List of all Ongoing Government & Private Contracts including contracts awarded but not yet started

Business Name : _____
 Business Address : _____

Name of Contract/ Project Cost	a. Owner's Name b. Address c. Telephone Nos.	Nature of Work	Bidder's Role		a. Date Awarded b. Date Started c. Date of Completion	% of Accomplishment		Value of Outstanding Works/Undelivered Portion
			Description	%		Planned	Actual	
<u>Government</u>								
<u>Private</u>								

Note: This statement shall be supported with Notice of Award and/or Contract:

Total Cost

Submitted by : _____
 (Printed Name & Signature)
 Designation : _____
 Date : _____

COMPUTATION OF NET FINANCIAL CONTRACTING CAPACITY

- A. Summary of the Applicant Supplier’s/Distributor’s/Manufacturer’s assets and liabilities on the basis of the attached income tax return and audited financial statement, stamped “RECEIVED” by the Bureau of Internal Revenue or BIR authorized collecting agent, for the immediately preceding year and a certified copy of Schedule of Fixed Assets particularly the list of construction equipment.

Year 20 _____	Amount
Total Assets	
Current Assets	
Total Liabilities	
Current Liabilities	
Net Worth (1-3)	
Net Working Capital (2-4)	

- B. The Net Financial Contracting Capacity (NFCC) based on the above data is computed as follows:

NFCC= [(Current assets minus current liabilities) (15)] minus the value of all outstanding or uncompleted portions of the projects under ongoing contracts, including awarded contracts yet to be started, coinciding with the contract to be bid.

The values of the domestic bidder's current assets and current liabilities shall be based on the latest Audited Financial Statements (AFS) submitted to the BIR.

The Bidder shall attach the AFS to the NFCC Computation for Eligibility Check Form.

NFCC = P _____

Submitted by:

Name of Supplier/Distributor/Manufacturer

Signature of Authorized Representative

Date:

NOTE:

If Partnership or Joint Venture, each Partner or Member Firm of Joint Venture shall submit the requirements.

Name of the Procuring Entity: UNIVERSITY OF THE PHILIPPINES VISAYAS

JOINT VENTURE AGREEMENT

KNOW ALL MEN BY THESE PRESENTS:

That this JOINT VENTURE AGREEMENT entered into By and
 Between _____, of legal age, _____
Name Designation
 Owner/proprietor of _____
Name of Company

And a resident of _____
Address of the Bidder

and

_____, of legal age, _____,
Name Civil Status

Owner/proprietor _____, a resident of
Name of Company

_____.

That both parties agree to join together their capital, manpower, equipment and other resources and efforts to enable the Joint Venture to participate in the Eligibility Check, Bidding and Undertaking of the hereunder stated Contract of the (Name of the Procuring Entity).

NAME OF THE PROJECT	CONTRACT AMOUNT

That both parties agree to be jointly and severally liable for their participation in the Eligibility Check, Bidding and Undertaking of the said contract.

That both parties agree that _____ and/or _____
 Shall be the official Representative of the Joint Venture, and are granted full power and authority to do, execute and perform any and all acts necessary and/or to represent the Joint Venture in the Eligibility Check, Bidding and Undertaking of the said contract, as fully and effectively and the Joint Venture may do and if personally present with full power of substitution and revocation.

That this Joint Venture Agreement shall remain in effect only for the above stated Contracts until terminated by both parties.

Done this _____ day of _____ 2022.

If the bidder is a joint venture, one of the requirements for Eligibility is the submission of a valid joint venture agreement

ACKNOWLEDGEMENT

SUBSCRIBED AND SWORN to before me this ____ day of _____, 2022, affiant exhibited to me his/her Identification Card _____ issued on _____ at _____, Philippines.

Notary Public
Until 31 December 2022
PTR No. : _____
Issued at : _____
Issued on: _____
TIN No. : _____

Doc. No. _____
Page No. _____
Book No. _____
Series of _____

QUESTIONNAIRE FOR PROSPECTIVE BIDDERS

(additional requirement for eligibility)

1. Have you ever participated in any bidding in the University of the Philippines System?

Yes	No

If YES, fill up the table below. Use additional pages if necessary.

Consistent University/ UP Campus	Name of Project	Amount of Project	Duration Start/ End	Status (On-going/ completed)

2. Has your company ever been suspended or blacklisted by the University of the Philippines System?

Yes	No

If YES, fill up the table below. Use additional pages if necessary.

Consistent University/ UP Campus	Name of Project	Amount of Project	Duration Start/ End	Status (On-going/ lifted)

3. Has your company ever been suspended or blacklisted by any government agency or private company?

Yes	No

If YES, fill up the table below. Use additional pages if necessary.

Consistent University/ UP Campus	Name of Project	Amount of Project	Duration Start/ End	Status (On-going/ lifted)

4. Has there ever been any project of your company in the University of the Philippines that was terminated by the Administration?

YES	NO	NA

If YES, fill up the table below. Use additional pages if necessary.

Consistent University/ UP Campus	Name of Project	Reason for termination	Date of Termination

5. Do you certify that all documents submitted by your company and personnel are authentic?

Yes	No

6. Is there any pending investigation and/or case filed against your company or your personnel to any court or any similar institutions in relation to any government contracts awarded to your company? In relation to practice of profession of any personnel?

Yes	No

If YES, fill up the table below. Use additional pages if necessary.

For Company

Case Filed	Where Filed	Date Filed	Status (On-going/ resolved)	Remarks

For Personnel

Name of Personnel & Designation	Case Filed	Where Filed	Data Filed	Status (On-going/resolved)	Remarks

I hereby certify that all statements and information provided herein are complete, true and correct.

Name & Signature of Bidder's: _____

Authorized Representative: _____

Official Designation: _____

Company: _____

Date: _____

ACKNOWLEDGEMENT

SUBSCRIBED AND SWORN to before me this _____ day of _____, 2022, affiant exhibited to me his/her Identification Card _____ issued on _____ at _____, Philippines.

Notary Public
 Until 31 December 2022
 PTR No. : _____
 Issued at : _____
 Issued on: _____
 TIN No. : _____

Doc. No. _____
 Page No. _____
 Book No. _____
 Series of _____

BID-SECURING DECLARATION

Bidding Activity No./Description: _____

To: UNIVERSITY OF THE PHILIPPINES VISAYAS

I/We, the undersigned, declare that:

1. I/We understand that, according to your conditions, bids must be supported by a Bid Security, which may be in the form of a Bid Securing Declaration.
2. I/We accept that: (a) I/we will be automatically disqualified from bidding for any procurement contract with any procuring entity for a period of two (2) years upon receipt of your Blacklisting Order; and, (b) I/we will pay the applicable fine provided under Section 6 of the Guidelines on the Use of Bid Securing Declaration, within fifteen (15) days from receipt of the written demand by the procuring entity for the commission of acts resulting to the enforcement of the bid securing declaration under Sections 23.1(b), 34.2, 40.1 and 69.1, except 69.1(f), of the IRR of RA No. 9184; without prejudice to other legal action the government may undertake.
3. I/We understand that this Bid Securing Declaration shall cease to be valid on the following circumstances:
 - a. Upon expiration of the bid validity period, or any extension thereof pursuant to your request;
 - b. I am/we are declared ineligible or post-disqualified upon receipt of your notice to such effect, and (i) I/we failed to timely file a request for reconsideration or (ii) I/we filed a waiver to avail of said right; and
 - c. I am/we are declared the bidder with the Lowest Calculated Responsive Bid, and I/we have furnished the performance security and signed the Contract.

IN WITNESS WHEREOF, I/We have hereunto set my/our hand/s this ____ day of [month] [year] at [place of execution].

[Insert NAME OF BIDDER OR ITS
AUTHORIZED
REPRESENTATIVE]
[Insert signatory's legal capacity]
Affiant

ACKNOWLEDGEMENT

SUBSCRIBED AND SWORN to before me this _____ day of _____, 2022, affiant exhibited to me his/her Identification Card _____ issued on _____ at _____, Philippines.

Notary Public
Until 31 December 2022
PTR No. : _____
Issued at : _____
Issued on: _____
TIN No. : _____

Doc. No. _____
Page No. _____
Book No. _____
Series of _____

Name of the Procuring Entity: UNIVERSITY OF THE PHILIPPINES VISAYAS
 Name of Project:

BID SECURITY: BANK GUARANTEE

WHEREAS, _____ (hereinafter
 (Name of the Bidder)
 called "the Bidder") has submitted his bid dated _____
 for the above-mentioned projects of the University.

KNOW ALL MEN by these presents that we _____
 (Name of the Bank)
 of _____ having our registered office at _____
 _____ (hereinafter called "the Bank") are bound
 unto UNIVERSITY OF THE PHILIPPINES VISAYAS (hereinafter called the "Entity) in the sum of
 _____ for
 which payment well and truly to be made to the said UNIVERSITY, the Bank binds himself, his
 successors and assigns by these presents.

SEALED with the Common Seal of the said Bank this _____ day of _____, 2022.

THE CONDITIONS of this obligation are that:

- if the Bidder withdraws his Bid during the period of bid validity specified in the Form of Bid; or
- if the Bidder does not accept the correction of arithmetical errors of his bid price in accordance with the Instructions to Bidder; or
- if the Bidder having been notified of the acceptance of his bid and award of contract to him by the Entity during the period of bid validity:
 - a. fails or refuses to execute the Form of Contract in accordance with the Instruction to Bidders, if required; or
 - b. fails or refuses to furnish the Performance Security in accordance with the Instructions to Bidders;

we undertake to pay to the UNIVERSITY OF THE PHILIPPINES VISAYAS up to the above amount receipt of his first written demand, without the UNIVERSITY OF the PHILIPPINES VISAYAS having to substantiate its demand, provided that in his demand the UNIVERSITY will note that the amount claimed by it is due to the occurrence of any one or the combination of the three (3) conditions stated above.

The Guarantee will remain in force up to and including the date _____
 days after the deadline for submission of Bids as such deadline is stated in the Instructions to Bidders or as it may be extended by the UNIVERSITY, notice of which extension to the Bank is hereby waived. Any demand in respect of this Guarantee should reach the Bank not later than the above date.

Date: _____ Signature of the Bank: _____

WITNESS _____ SEAL _____

 (Signature, Name and Address)

**AUTHORITY OF SIGNATORY
SPECIAL POWER OF ATTORNEY**

I, _____, President of _____, a corporation incorporated under the laws of _____ with its registered office at _____, by virtue of Board Resolution No. _____ dated _____, has made, constituted and appointed _____ true and lawful attorney, for it
(Name of the Authorized Representative)

and its name, place and stead, to do, execute and perform any and all acts necessary and/or represent _____
(Name of the Company)
in the bidding of the project:

as fully and effectively as corporation might do if personally present with full power of substitution and revocation and hereby confirming all that said representative shall lawfully do or cause to be done by virtue hereof.

IN WITNESS WHEREOF, I have hereunto set my hand this ___ day of _____, 2022 at _____.

Signed in the Presence of,

ACKNOWLEDGEMENT

SUBSCRIBED AND SWORN to before me this _____ day of _____, 2022, affiant exhibited to me his/her Identification Card _____ issued on _____ at _____, Philippines.

Notary Public
Until 31 December 2022
PTR No. : _____
Issued at : _____
Issued on: _____
TIN No. : _____

Doc. No. _____
Page No. _____
Book No. _____
Series of _____

Note: The Authority of the Signature is a requirement in the Technical Envelope. For Single Proprietorship, there must be an affidavit of the owner or a Special Power of Attorney; for Partnership, a partnership resolution from the General Manager or President; for Corporation, a board resolution with secretary's certificate; for Joint Venture, a resolution signed by all the joint-venture partners.

Name of the Procuring Entity: UNIVERSITY OF THE PHILIPPINES VISAYAS

**AUTHORITY OF SIGNATORY
SECRETARY'S CERTIFICATE
(For Corporation)**

I, _____, a duly elected and qualified Corporate
(Name of the Representative)
Secretary of _____, a corporation duly organized and
(Name of the Company)
existing under and by virtue of the law of the _____, DO HEREBY
CERTIFY, that:

I am familiar with the facts herein certified and duly authorized to certify the same:

At the regular meeting of the Board of Directors of the said Corporation duly convened and held on _____ at which meeting a quorum was present and acting throughout, the following resolutions were approved, and the same have not been annulled, revoked and amended in any way whatever and are in full force and effect on the date hereof:

RESOLVED, that _____ be, as it hereby is,
(Name of the Company)
authorized to participate in the bidding of the project:

by the **University of the Philippines Visayas**; and that if awarded the Contract shall enter into a contract with the **University of the Philippines Visayas**; and in connection therewith hereby appoints _____, acting as duly

(Name of the authorized representative)
authorized and designated representative of _____, are
(Name of the Company)

granted full power and authority to do, execute and perform any and all acts necessary and/or to represent _____ in the bidding as fully and

(Name of the Company)
effectively as the _____ might do if personally
(Name of the Company)

present with full power of substitution and revocation and hereby satisfying and confirming all that my said representative shall lawfully do or cause to be done by virtue hereof;

RESOLVED FURTHER THAT, the Board hereby authorizes its President to:

execute a waiver of jurisdiction whereby the _____
(Name of the Bidder/Company)

hereby submits itself to the jurisdiction of the Philippine Government and hereby waives its right to question the jurisdiction of the Philippine courts;

execute a waiver that the _____ shall not seek
(Name of the Bidder/Company)

and obtain writ of injunctions or prohibition or restraining order against U.P. Visayas or any other agency in connection with this Contract to prevent and restrain the bidding procedures related thereto, the negotiating of and award of a contract to a successful bidder, and the carrying out of the awarded contract

WITNESS the signature of the undersigned as officer of the said company this _____ day of _____, 2022.

Corporate Secretary

ACKNOWLEDGEMENT

SUBSCRIBED AND SWORN to before me this _____ day of _____, 2022, affiant exhibited to me his/her Identification Card _____ issued on _____ at _____, Philippines.

Notary Public
Until 31 December 2022
PTR No. : _____
Issued at : _____
Issued on: _____
TIN No. : _____

Doc. No. _____
Page No. _____
Book No. _____
Series of _____

Note: The Authority of the Signature is a requirement in the Technical Envelope. For Single Proprietorship, there must be an affidavit of the owner or a Special Power of Attorney; for Partnership, a partnership resolution from the General Manager or President; for Corporation, a board resolution with secretary's certificate; for Joint Venture, a resolution signed by all the joint-venture partners.

Name of the Procuring Entity: UNIVERSITY OF THE PHILIPPINES VISAYAS

Name of Project:

MANPOWER UTILIZATION SCHEDULE

CATEGORY	MONTH											
	1	2	3	4	5	6	7	8	9	10	11	12
Contractor's Name	Name of the Procuring Entity: University of the Philippines Visayas					Contract Name:						

Submitted by:

Name of the Representative of the Bidder

Date

Position

Name of the Bidder

Name of the Procuring Entity: UNIVERSITY OF THE PHILIPPINES VISAYAS

Name of Project:

**OUTLINE
NARRATIVE DESCRIPTION
OF
CONSTRUCTION METHODS**

1.0 INTRODUCTION

Refer to Bidding, etc.

2.0 BRIEF DESCRIPTION OF CONTRACT WORKS

State general features of contract works. Use tables if necessary.

3.0 CONSTRUCTION METHODS AND PROCEDURES

3.1 Methodology or General Approach

State General approach in construction in terms of use of equipment-intensive or labor –based methods, any special techniques, methods or procedures to ensure completion on time and quality of construction financing the project, etc.

3.2 Program of Work

CPM, Progress Bar Schedule and Development Schedule submitted.

3.3 Financial Program

Cash Flow schedules, provisions for working capital, schedule of receipts

The narrative description of construction procedure/methods is required to be in the Technical Envelope of the bidder. The above is the recommended outline in the bidder's presentation of the documents.

Name of the Procuring Entity: UNIVERSITY OF THE PHILIPPINES VISAYAS

Name of Project:

**CONTRACTOR'S ORGANIZATIONAL CHART
FOR THE CONTRACT**

Submit a copy of the organizational chart that the contractor's intend to use to execute the contract if awarded to him. Indicate in the chart the names of the project manager, supervising civil engineer or architect, foreman, electrician and carpenter assigned to the project above stated.

1. This organizational chart should represent the Contractor's Organization" required for the project, and not the organizational chart of the entire firm.
2. The bidders shall comply with and submit "Key Personnel's Certificate of Employment" for each key personnel.
3. Each such nominated engineer/key personnel shall comply with and submit "Key Personnel (Bio-Data) and qualification of key personnel to be assigned to the contract.

Name of the Procuring Entity: UNIVERSITY OF THE PHILIPPINES VISAYAS

Name of Project:

QUALIFICATION OF KEY PERSONNEL PROPOSED TO BE ASSIGNED TO THE CONTRACT

Contractor: _____

Address: _____

1. Name						
2. Address						
3. Date of Birth						
4. Employed Since						
5. Experience						
6. Previous						
7. Education						
8. PRC License						

Contractors to indicate Minimum Manpower Requirements for each projects.

Note: Attached individual resume and PRC License of the (professional) personnel.

Submitted by: _____
(Printed Name & Signature)

Designation: _____

Date: _____

Other Positions deemed required by the Applicant for this project:

Name of the Procuring Entity: UNIVERSITY OF THE PHILIPPINES VISAYAS

Name of Project:

**KEY PERSONNEL
(FORMAT OF BIO-DATA)**

Give the detailed information of the following personnel who are schedule to be assigned as full-time field staff for the project. (Fill up a form for each person).

Authorized Managing Officer/Representative: _____

Sustained Technical Employee:

- 1. Name :
- 2. Date of Birth :
- 3. Nationality :
- 4. Education and Degrees :
- 5. Specialty :
- 6. Registration :
- 7. Length of Service with the Firm : ____ Year from ____ (months) ____ (years)
To ____ (months) ____ (years)
- 8. Years of Experience

9. If Item 7 is less than ten (10) years, give name and length of service with previous employers for a ten (10) year period (attached additional sheet/s), if necessary:

<u>Name and Address of Employer</u>	<u>Length of Service</u>
	_____ year(s) from ____ to _____
	_____ year(s) from ____ to _____
	_____ year(s) from ____ to _____

Experiences

This should cover the past ten (10) years of experience. (Attached as many pages as necessary to show involvement of personnel in projects using the format below).

- 1. Name :
- 2. Date of Birth :
- 3. Name and Address of the Owner's Engineer (Consultant)
- 4. Indicate the Features of Project (particulars of the project components and any other particular interest connected with the project):
- 5. Contract Amount Expressed in Philippine Currency
- 6. Position
- 7. Structures for which the employee was responsible
- 8. Assignment Period from ____ (months) ____ (years)
to ____ (months) ____ (years)

Name and Signature of Employee

It is hereby certify that the above personnel can be assigned to this project, if the contract is awarded to our company

Place and Date

(Authorized Representative)

Name of the Procuring Entity: UNIVERSITY OF THE PHILIPPINES VISAYAS
Name of Project:

KEY PERSONNEL'S CERTIFICATE OF EMPLOYMENT

_____ Date

Dr. Clement C. Camposano
 Chancellor
 U.P. Visayas
 Miagao, Iloilo

Thru: MS. ARLENE N. AVANCEÑA
 Chair, Bids and Awards Committee

Dear Sir/ Madame

I am _____, a Licensed _____ Engineer
 With Professional License No. _____ issued on _____

I hereby certify that _____ has engaged my
 (Name of the Bidder/Company)
 services as _____ for above mentioned project, if awarded to it.
 (Designation)

As _____ I supervised the following completed projects similar
 (Designation)
 to the contract under bidding:

Name of Project	Owner	Cost	Date Completed

At present, I am supervising the following projects:

Name of Project	Owner	Cost	Date Completed

In case of my separation for any reason whatsoever from the above-mentioned Contractor, I shall notify the UP Visayas at least twenty one (21) days before the effective date of my separation.

As _____, I now I will have to stay in the job site all the time
 (Designation)
 to supervise and manage the Contract works to the best of my ability, and aware that I am authorized to handle only one (1) contract at a time.

I do not allow the use of my name for the purpose of enabling the above-mentioned Contractor to qualify for the Contract without any firm commitment on my part to assume the post of

_____ therefore, if the contract is awarded to him since I understand that to do so will be a sufficient ground for my disqualification as _____ in any future UP Visayas bidding or employment with any Contractor doing business with the UP Visayas.

 (Signature of Operations Manager)

ACKNOWLEDGEMENT

SUBSCRIBED AND SWORN to before me this _____ day of _____, 2022, affiant exhibited to me his/her Identification Card _____ issued on _____ at _____, Philippines.

Notary Public
Until 31 December 2022
PTR No. : _____
Issued at : _____
Issued on: _____
TIN No. : _____

Doc. No. _____
Page No. _____
Book No. _____
Series of _____

Name of the Procuring Entity: UNIVERSITY OF THE PHILIPPINES VISAYAS

Name of Project:

CONTRACTOR'S LETTER-CERTIFICATE TO PROCURING ENTITY

Dr. Clement C. Camposano
Chancellor
U.P. Visayas
Miag-ao, Iloilo

Dear Chancellor Camposano:

Supplementing our Organizational Chart for the Contract, we have the honor to submit herewith, and to certify as true and correct, the following pertinent information:

1. That I/we have engaged the services of _____, to be the _____ of the above-mentioned project, who is a _____ with Professional License Certificate No. _____ issued on _____ and who has performed the duties in the construction of the Contracts enumerated in the duly filed form _____.
2. The said _____ shall be designated by us as our _____ to personally perform the duties of the said position in the above-mentioned project, if and when the same is awarded in our favor.
3. The said _____ shall employ the best care, skill and ability in performing his duties in accordance with the Contract Agreement, conditions of contract, plans, specifications, special provisions and other provisions embodied in the proposed contract.
4. The said _____ shall be personally present at the job site to supervise the phase of the construction work pertaining to this assignment as _____ all the time.
5. That, in order to guarantee that said Engineer shall perform his duties properly and be personally present in the job site, he is hereby required to secure a certificate of appearance from the engineers of the University at the end of every month.

That, in the event that I/we elect or choose to replace said _____ with another Engineer, the University will be accordingly notified by us in writing at least twenty one (21) days before making the replacement. We will submit to the University, for prior approval, the name

of the proposed new _____, his qualifications, experience, list of projects undertaken and other relevant information.

6. That any willful violation on my/our part of the herein conditions may prejudice my/our standing as a reliable contractor in future bidding of the University.

Very truly yours,

Authorized Representative of Bidder

CONCURRED IN:

Name of Engineer

Address

ACKNOWLEDGEMENT

SUBSCRIBED AND SWORN to before me this _____ day of _____, 2022, affiant exhibited to me his/her Identification Card _____ issued on _____ at _____, Philippines.

Notary Public
Until 31 December 2022
PTR No. : _____
Issued at : _____
Issued on: _____
TIN No. : _____

Doc. No. _____
Page No. _____
Book No. _____
Series of _____

Name of the Procuring Entity: UNIVERSITY OF THE PHILIPPINES VISAYAS

Name of Project:

LIST OF EQUIPMENT, OWNED OR LEASED AND/OR UNDER PURCHASE AGREEMENTS, PLEDGED TO THE PROJECT CONTRACT

Contractor : _____

Address : _____

<i>Description</i>	<i>Model/Year</i>	<i>Capacity/Performance/Size</i>	<i>Plate No.</i>	<i>Motor No./ Body No.</i>	<i>Location</i>	<i>Condition</i>	<i>Proof of Ownership/Lessor or Vendor</i>
A. Owned							
B. Leased							
C. Under Purchase Agreements							

List of minimum equipment required for the project:

Submitted by : _____
(Printed Name & Signature)

Designation : _____

Date : _____

Name of the Procuring Entity: UNIVERSITY OF THE PHILIPPINES VISAYAS

Name of Project:

EQUIPMENT UTILIZATION SCHEDULE

Category/Equipment	Month												
	1	2	3	4	5	6	7	8	9	10	11	12	
Contractor's Name:	Name of the Procuring Entity: UNIVERSITY OF THE PHILIPPINES VISAYAS					Contract Name:							

Submitted by:

Name of the Representative of the Bidder: _____
 Position : _____
 Name of the Bidder : _____
 Date : _____



UNIVERSITY OF THE PHILIPPINES VISAYAS

BIDS AND AWARDS COMMITTEE

Miagao, Iloilo, Philippines 5023
Telephone/Telefax Nos. (033)3159858 (SITECO)
email:spsoc@upv.edu.ph

CERTIFICATE OF SITE INSPECTION

This is to certify that _____ a representative

of _____ has conducted
a site inspection on the project:

“RENOVATION OF HEALTH SERVICES UNIT (ITB-2024-008)”

This certification is issued in connection for the bidding scheduled on 19 April 2024, 9:00AM.

UPV AUTHORIZED REPRESENTATIVE

Date: _____

Omnibus Sworn Statement (Revised)
[shall be submitted with the Bid]

REPUBLIC OF THE PHILIPPINES)
CITY/MUNICIPALITY OF _____) S.S.

AFFIDAVIT

I, [Name of Affiant], of legal age, [Civil Status], [Nationality], and residing at [Address of Affiant], after having been duly sworn in accordance with law, do hereby depose and state that:

1. *[Select one, delete the other:]*

[If a sole proprietorship:] I am the sole proprietor or authorized representative of [Name of Bidder] with office address at [address of Bidder];

[If a partnership, corporation, cooperative, or joint venture:] I am the duly authorized and designated representative of [Name of Bidder] with office address at [address of Bidder];

2. *[Select one, delete the other:]*

[If a sole proprietorship:] As the owner and sole proprietor, or authorized representative of [Name of Bidder], I have full power and authority to do, execute and perform any and all acts necessary to participate, submit the bid, and to sign and execute the ensuing contract for [Name of the Project] of the [Name of the Procuring Entity], as shown in the attached duly notarized Special Power of Attorney;

[If a partnership, corporation, cooperative, or joint venture:] I am granted full power and authority to do, execute and perform any and all acts necessary to participate, submit the bid, and to sign and execute the ensuing contract for [Name of the Project] of the [Name of the Procuring Entity], as shown in the attached [state title of attached document showing proof of authorization (e.g., duly notarized Secretary's Certificate, Board/Partnership Resolution, or Special Power of Attorney, whichever is applicable)];

3. [Name of Bidder] is not "blacklisted" or barred from bidding by the Government of the Philippines or any of its agencies, offices, corporations, or Local Government Units, foreign government/foreign or international financing institution whose blacklisting rules have been recognized by the Government Procurement Policy Board, **by itself or by relation, membership, association, affiliation, or controlling interest with another blacklisted person or entity as defined and provided for in the Uniform Guidelines on Blacklisting;**

4. Each of the documents submitted in satisfaction of the bidding requirements is an authentic copy of the original, complete, and all statements and information provided therein are true and correct;

5. [Name of Bidder] is authorizing the Head of the Procuring Entity or its duly authorized representative(s) to verify all the documents submitted;

6. *[Select one, delete the rest:]*

[If a sole proprietorship:] The owner or sole proprietor is not related to the Head of the Procuring Entity, members of the Bids and Awards Committee (BAC), the Technical Working Group, and the BAC Secretariat, the head of the Project Management Office or the end-user unit, and the project consultants by consanguinity or affinity up to the third civil degree;

[If a partnership or cooperative:] None of the officers and members of [Name of Bidder] is related to the Head of the Procuring Entity, members of the Bids and Awards Committee (BAC), the Technical Working Group, and the BAC Secretariat, the head of the Project Management Office or the end-user unit, and the project consultants by consanguinity or affinity up to the third civil degree;

[If a corporation or joint venture:] None of the officers, directors, and controlling stockholders of [Name of Bidder] is related to the Head of the Procuring Entity, members of the Bids and Awards Committee (BAC), the Technical Working Group, and the BAC Secretariat, the head of the Project Management Office or the end-user unit, and the project consultants by consanguinity or affinity up to the third civil degree;

7. [Name of Bidder] complies with existing labor laws and standards; and

8. [Name of Bidder] is aware of and has undertaken the responsibilities as a Bidder in compliance with the Philippine Bidding Documents, which includes:

- a. Carefully examining all of the Bidding Documents;
 - b. Acknowledging all conditions, local or otherwise, affecting the implementation of the Contract;
 - c. Making an estimate of the facilities available and needed for the contract to be bid, if any; and
 - d. Inquiring or securing Supplemental/Bid Bulletin(s) issued for the *[Name of the Project]*.
9. *[Name of Bidder]* did not give or pay directly or indirectly, any commission, amount, fee, or any form of consideration, pecuniary or otherwise, to any person or official, personnel or representative of the government in relation to any procurement project or activity.
10. **In case advance payment was made or given, failure to perform or deliver any of the obligations and undertakings in the contract shall be sufficient grounds to constitute criminal liability for Swindling (Estafa) or the commission of fraud with unfaithfulness or abuse of confidence through misappropriating or converting any payment received by a person or entity under an obligation involving the duty to deliver certain goods or services, to the prejudice of the public and the government of the Philippines pursuant to Article 315 of Act No. 3815 s. 1930, as amended, or the Revised Penal Code.**

IN WITNESS WHEREOF, I have hereunto set my hand this ___ day of ___, 2022 at _____, Philippines.

Bidder's Representative/Authorized Signatory

ACKNOWLEDGEMENT

SUBSCRIBED AND SWORN to before me this _____ day of _____, 2022, affiant exhibited to me his/her Identification Card _____ issued on _____ at _____, Philippines.

Notary Public
Until 31 December 2022
PTR No. : _____
Issued at : _____
Issued on: _____
TIN No. : _____

Doc. No. _____
Page No. _____
Book No. _____
Series of _____

DRAFT**A G R E E M E N T****KNOW ALL MEN BY THESE PRESENTS:**

This Agreement entered into and executed by and between

THE UNIVERSITY OF THE PHILIPPINES VISAYAS, a constituent unit of the UNIVERSITY OF THE PHILIPPINES, the national university of the Philippines, established and existing by the virtue of Executive Order No. 628 s. 1980 and Republic Act No. 9500, with principal office at Miag-ao, Iloilo, represented herein by its Chancellor, **DR. CLEMENT C. CAMPOSANO** hereinafter referred to as ("**UP VISAYAS**") of the one part;

- and -

_____, with business address at _____, represented by its _____, _____ (hereinafter called the "CONTRACTOR") of the other part;

WITNESSETH that:

WHEREAS, the UNIVERSITY OF THE PHILIPPINES VISAYAS has the necessary funds for the undertaking the project: " _____ located at _____;

WHEREAS, an Invitation to Bid for the Project was published/advertised for public, posted at the PhilGEPS and in conspicuous places within the premises of UPV Iloilo City on _____;

WHEREAS, in response to said advertisement, three (3) prospective bidders signified their intentions to join the bidding and bought the bid documents;

- a.
- b.
- c.

WHEREAS, on _____, during the opening of bids, the above mentioned bidders, was declared "eligible" and "complying" having complied with the documentary requirements of the Eligibility, Technical and Financial;

WHEREAS, after thorough validation and verification of the performance of the bidder, the Committee considered the bid proposal of _____, as most advantageous to the University.

NOW THEREFORE, for and in consideration of the foregoing premises, the parties hereto agree as follows:

**ARTICLE I
(CONTRACTOR'S RESPONSIBILITY)**

The CONTRACTOR, shall within ten (10) days from signing of this contract appear before the UNIVERSITY for purpose of receiving the Notice to Proceed. In case of failure of the CONTRACTOR to appear within the period herein stipulated, the UNIVERSITY shall send a copy of the Notice to Proceed to the known address of the CONTRACTOR, despite notice, still fail to prosecute the project within the period specified in the Notice to Proceed, the CONTRACTOR shall be deemed to have abandoned the contract and the UNIVERSITY may unilaterally rescind the contract.

The contractor shall not, in whole or in part, sub-contract, assign or allow any person to undertake the project at any given time, otherwise, the UNIVERSITY shall have the right to unilaterally rescind the contract,

without notice to the CONTRACTOR and recover liquidated damages in an amount equivalent of five per cent (5%) of the project cost.

In the prosecution of the project, the CONTRACTOR shall provide all labor supervision, materials, construction equipment, plant and all other things, whether of a temporary or permanent nature, required in the execution and maintenance of the works and or for remedying of any defects therein, to the extent that such obligation is specified in or is reasonably inferred from the contract.

In complying with the obligations under the contract, the CONTRACTOR shall exercise due diligence and care. The CONTRACTOR shall be responsible for the adequacy, stability and safety of the site operations and method of construction employed.

A CONTRACTOR shall observe and comply with all laws, ordinances and regulations and shall protect and indemnify the UNIVERSITY against any claim or liability arising from the violation thereof, whether by the CONTRACTOR himself, the employees or the subcontractors, trustees, assignees should the CONTRACTOR, in violation of paragraph D hereof, subcontract entrust or assign or allow any person to undertake the project at any given time.

The CONTRACTOR shall pay all permits and pay all charges, fees and taxes and give all notices necessary and incidental to the due and lawful prosecution of the work.

The CONTRACTOR shall, under his name and its own expense, obtain and maintain, for the duration of this Agreement, the following insurance coverage subject to the conditions of Section 15 of the General Conditions of the Bidding Documents:

- a. Contractor's All Risk Insurance;
- b. Transportation to the project site of Equipment, Machinery and Supplies owned by the Contractor;
- c. Personal Injury or death of Contractor's employees; and
- d. Comprehensive insurance for the third party liability to Contractor's direct or indirect act or omission causing damage to the third persons.

The CONTRACTOR shall deposit to the UNIVERSITY the amount of TEN THOUSAND PESOS (P10,000.00) to cover miscellaneous costs (i.e. electricity, water consumption, etc.) the CONTRACTOR may incur during the Contract implementation.

The CONTRACTOR shall abide and comply with the provisions of Republic Act No. 9184 (Government Procurement Reform Act), its Implementing Rules and Regulations and Annex "E" thereof (Contract Implementation Guidelines for the Procurement of Infrastructure Project).

The parties may, in writing, agree to any revision, alteration or addition to the terms and conditions of this Agreement of the Contract Documents.

ARTICLE II (UNIVERSITY'S RESPONSIBILITY)

The UNIVERSITY shall pay the CONTRACTOR the amount of _____ **PESOS ONLY (P_____)**.

The UNIVERSITY's responsibility to pay the CONTRACTOR shall be subject to the following conditions:

1. Progress Billing
 - a. Every month (or quarter) , the CONTRACTOR may submit a request for payment for the work accomplished. Such request for payment shall be verified and certified by the supervising Architech/Engineer and the Vice Chancellor for Planning and Development.
 - b. The UNIVERSITY shall have the right to deduct from the CONTRACTOR's progress billing such amount as may be necessary to cover third party liabilities, as well as uncorrected defects in the project.
2. Retention Money
 - a. Progress payment are subject to retention of ten percent (10%) referred to as "retention money". Such retention shall be based on the total amount due to the CONTRACTOR prior to any deduction and shall be retained from every progress payment until fifty per cent (50%) of the value of the works, as determined by the UNIVERSITY, are completed. If after fifty per cent

(50%) completion, the work is satisfactorily done and on schedule, no additional retention shall be made otherwise the ten percent (10%) retention shall be imposed.

- b. The total "retention money" shall be due for release upon final acceptance of the works. The CONTRACTOR may however, request the substitution of the retention money for each progress billing with irrevocable standby letters of credit from a commercial bank, bank guaranties or surety bond callable on demand of amount equivalent to the retention money substituted for and acceptable to Government, provided that project is on schedule and is satisfactorily undertaken.

3. Advance Payment

The UNIVERSITY shall upon written request of the contractor which shall be submitted as a contract document, make an advance payment to the CONTRACTOR in an amount not exceeding fifteen percent (15%) of the total contract price.

The advance payment shall be made only upon the submission to and acceptance by the UNIVERSITY of an irrevocable standby letter of credit of equivalent value from a commercial bank, a bank guarantee or a surety bond callable on demand, issued by a surety or insurance company duly license by the Insurance Commission and confirmed by the procuring entity.

The advance payment shall be repaid by the CONTRACTOR by deducting fifteen percent (15%) from his periodic progress payments a percentage equal to the percentage of the total contract price used for the advance payment.

The CONTRACTOR may reduce his standby letter of credit or guarantee instrument by the amounts refunded by the Monthly Certificates in the advance payment.

Both parties agree that the total price stated herein already include all applicable taxes, licenses, permits, fees, charges and duties required by the government.

The Contract Price is inclusive of all duties, taxes, licenses, permits, fees and charges which may accrue by virtue of the PROJECT, such as but not limited to permit and registration fees, municipal and personal property taxes, fees for storage or consumption, employment taxes, payments and contributions imposed by law, and insurance.

All such fees shall be for the account of the CONTRACTOR.

Any exemption in the payment of the foregoing shall be credited to the UNIVERSITY. The CONTRACTOR is obligated to inform the UNIVERSITY in writing of any exemptions obtained by or granted to it with respect to taxes, licenses, and other fees. The CONTRACTOR shall pay all costs incurred in the preparation of this Agreement, including notarial fees.

Any amount payable to the CONTRACTOR may be compensated against liquidated damages payable to the UNIVERSITY under this Agreement.

ARTICLE III (CONSIDERATION / CONTRACT PRICE)

For and in consideration of the full, satisfactorily and faithful performance by the CONTRACTOR of the undertakings defined under this contract, the UNIVERSITY agrees to pay the CONTRACTOR for the lump sum contract in the amount of _____ **PESOS ONLY (P_____)** payable at times and in the manner prescribed under the pertinent provisions of RA 9184 and its revised IRR.

In case of price escalation, the CONTRACTOR shall be subjected to the guidelines on the price escalation as set in Sec 61 of the Revised IRR of RA 9184.

ARTICLE IV (COMPLETION TIME)

The Contract Time for the PROJECT is _____ (_____) **calendar days** to commence on the 3rd day upon the receipt of the Notice to Proceed issued by the UNIVERSITY.

Time being of the essence of the PROJECT, delay in the completion of the PROJECT may be excusable only if the same is due to force majeure, additional work approved by the UNIVERSITY, or for any other special circumstance as may be determined by the UNIVERSITY.

In the event that the delivery of services cannot be completed within the prescribed period because of force majeure and such other causes not attributable to the CONTRACTOR, the latter shall not be held liable.

Force majeure is defined as any circumstance beyond the control of the parties which directly prevent the parties from performing their obligations such as, but not limited to extraordinary weather conditions, fires, earthquakes or other natural calamities, valid work stoppage or suspension, orders of competent authority, civil disorder, war, and other hostilities.

Should there arise any circumstance provided in the foregoing paragraphs of this Article which affects the performance of its obligations, the party concerned shall notify the other in writing setting forth such facts and circumstances, within five (5) days of its occurrence. Should there be need to extend the period of compliance with its obligations, both parties shall agree on a reasonable period within which to comply with the undertaking. Any other request for extension by the CONTRACTOR may be granted or denied by the UNIVERSITY at its sole discretion.

In no case shall extension of time for completion be granted in any of the following circumstances.

- a. Ordinary unfavorable weather conditions;
- b. Labor problems or disputes involving the Contractors' employees, workers, or personnel, or those of its sub-contractors, agents, or suppliers;
- c. When the reason given for the request for extension has already been considered in the determination of the original completion time.

ARTICLE V (PERFORMANCE SECURITY)

To ensure the faithful performance of this Agreement, the CONTRACTOR shall post a Performance Security, callable on demand, drawn in favor of UPV, in any of the following forms:

Form of Security	Maximum Amount in % of the Total Contract Price
a. Cash, Cashier's/Manager's Check issued by a Universal or Commercial Bank	Ten Percent (10%)
b. Bank Draft/Guarantee or irrevocable letter of credit issued by a Universal or Commercial Bank, Provided, however, that it shall be confirmed or authenticated by a Universal or Commercial Bank, if issued by a foreign bank	
c. Surety Bond callable upon demand issued by a surety or insurance company duly certified by the Insurance Commission as authorized to issue such security; and/or	Thirty Percent (30%)

The Performance Bond shall be conditioned for a faithful performance of this Agreement and to answer for such and all obligations and responsibilities of the **CONTRACTOR** arising out of, or in accordance with this Agreement and in the case of cash bond, this may be released only upon termination of the Contract, provided no claims have been filed against the **CONTRACTOR** for violation of any of the terms and conditions of the Agreement. Otherwise, the Performance Bond shall remain effective and shall not be released until the final disposition of the claim/s and upon the issuance of the **UNIVERSITY** of the Certificate of Final Acceptance of the services rendered.

ARTICLE VI WARRANTY

The **CONTRACTOR** warrants that within a period of One (1) year starting from the date of completion of the PROJECT, all works found to be defective in material or workmanship shall be replaced immediately by the **CONTRACTOR** free of charge. The warranty does not include repairs to be done when the problem results from accident, disaster, misuse and abuse of the work upon the **UNIVERSITY's** and the **CONTRACTOR's** proper confirmation. Within the warranty period, all defects in the work done shall be repaired or replaced at no extra charge to the **UNIVERSITY**.

The **CONTRACTOR** shall furnish the **UNIVERSITY** a WARRANTY SECURITY, in any of the following forms, effective for a period of One (1) year reckoned from the date of the FINAL COMPLETION, to wit:

FORMS OF SECURITY	MINIMUM AMOUNT IN % OF TOTAL CONTRACT PRICE

a. Cash deposit, Cash bond or Letter of Credit issued by a universal or commercial bank; provided, however, that the Letter of Credit shall be confirmed or authenticated by a universal or commercial bank, if issued by a foreign bank.	Five Percent (5%)
b. Bank Guarantee confirmed by a universal or commercial bank.	Ten Percent (10%)
c. Surety Bond callable upon demand issued by GSIS or a surety or insurance company duly certified by the Insurance Commission as authorized to issue such security.	Thirty Percent (30%)

Said Warranty Security shall be posted to answer for any loss, damage, injury or expenses which the UNIVERSITY may incur and to make good the defects in workmanship or materials that may become evident within One (1) year from the date of the FINAL COMPLETION. Provided, however, no payment for the final billing shall be released unless the Warranty Security has been posted

In case of structural defects/failure occurring during the applicable warranty period provided in **GCC** Clause 12.5, the Procuring Entity shall undertake the necessary restoration or reconstruction works and shall be entitled to full reimbursement by the parties found to be liable for expenses incurred therein upon demand, without prejudice to the filing of appropriate administrative, civil, and/or criminal charges against the responsible persons as well as the forfeiture of the warranty security posted in favor of the Procuring Entity.

ARTICLE VII LIQUIDATED DAMAGES

The CONTRACTOR shall complete the project as stated in Program of Works (**Annex "A"**) within the time prescribed in Article IV hereof. Should the contractor fail in the performance for reasons attributable to its fault or negligence, it shall pay a penalty of one-tenth of one percent (1/10 of 1%) of the cost of the unperformed portion of the works for everyday of delay. Such delay, however, shall not give rise to refusal or withholding of payment by UP VISAYAS for the services rendered.

Liquidated damages shall be imposed upon the CONTRACTOR if he fails to satisfactorily complete the work within the specified contract time and is considered in default under the Contract. The amount shall be determined in accordance with the formula provided under of R.A. 9184 and its Implementing Rules and Regulations, specifically Item 8, Annex "E" of said Rules, and shall be deducted from any money due or which may become due the CONTRACTOR.

The provisions on liquidated damages notwithstanding, the UNIVERSITY has the right to take all necessary and appropriate steps to effect an immediate takeover of the construction work either by itself or by another contractor, and to forfeit the Performance Bond and charge against the CONTRACTOR and its sureties any excess cost occasioned thereby in finishing the PROJECT, together with any liquidated damages that may be due the UNIVERSITY under any of the following circumstances:

- a. If the progress of the work is delayed by at least twenty percent (20%) of the Contract period plus any extension duly granted, or does not conform with the work schedule such that from all indications the CONTRACTOR may not be able to complete the PROJECT within the stipulated time; or
- b. If the construction is not in accordance with the approved plans and specifications; or
- c. If at any time during the progress of the work the CONTRACTOR should fail, refuse, or neglect to supply and provide the required tools, materials, supplies, equipment, facilities, and labor-workmen in accordance with the schedule; or
- d. If the CONTRACTOR should abandon, fail to continue with the construction; or
- e. If this Contract or any part hereof is being subcontracted or assigned to third parties without the previous written consent of the UNIVERSITY; or
- f. If the CONTRACTOR violates any of the conditions, warranties, or covenants under this Contract.

In the event of takeover, whatever contracts entered into by the CONTRACTOR in the pursuit of its obligations under this Agreement which the UNIVERSITY may want to assume are hereby deemed assigned to the UNIVERSITY; Provided, that the UNIVERSITY shall not be liable for unpaid obligations previously incurred by the CONTRACTOR prior to the takeover. The right of the UNIVERSITY to take over the PROJECT shall be without prejudice to other rights and legal remedies it may be entitled to.

The lawful occupation by the UNIVERSITY of any portion of the PROJECT shall not be deemed a waiver of any of its rights nor shall it diminish any liability of the CONTRACTOR for liquidated damages for delays in other portions of the PROJECT.

**ARTICLE VIII
(COMPLETION)**

The UNIVERSITY shall issue a CERTIFICATE OF COMPLETION to the CONTRACTOR, upon satisfactory completion of the Project. Minor defects discovered in the final inspection shall be corrected within NINETY (90) CALENDAR DAYS from issuance of Certificate of Completion; otherwise, the Performance Bond shall be forfeited.

The defects liability period for the infrastructure projects shall be one (1) year from the project completion up to the final acceptance by the University. During this period, the CONTRACTOR shall undertake the repair works, at his own expense, of any damage to the Works on account of the use of materials of inferior quality within NINETY (90) CALENDAR days from the time the UNIVERSITY has issued an order to undertake repair. In case of failure or refusal to comply with this mandate, the UNIVERSITY shall undertake such repair works and shall be entitled to full reimbursement of expenses incurred therein upon demand.

In case the CONTRACTOR fails to comply with preceding paragraph, the UNIVERSITY shall forfeit its performance security, subject its property(ies) to attachment or garnishment proceedings, and perpetually disqualify it from participating in any public bidding.

Before issuance of the CERTIFICATE of COMPLETION, the CONTRACTOR shall submit a Sworn Statement that all payrolls, materials, bills and other indebtedness and obligations for the work have been fully and duly paid. Any claim filed by any party arising from this Agreement shall be sufficient reason for the UNIVERSITY to withhold any payment due to the CONTRACTOR.

**ARTICLE IX
(FINAL ACCEPTANCE)**

The UNIVERSITY shall issue a CERTIFICATE of FINAL ACCEPTANCE to the CONTRACTOR, ONE (1) YEAR from the date of issuance of the CERTIFICATE of COMPLETION of the Project. Acceptance shall not be implied from any other act of the UNIVERSITY.

Notwithstanding the foregoing, the FINAL ACCEPTANCE of the UNIVERSITY shall not relieve the CONTRACTOR of any liability for any defect in the work. After Final Acceptance, in no case shall the CONTRACTOR, its representatives, personnel, or subcontractors, continue to occupy the premises and its surroundings.

**ARTICLE X
(CLAIMS AND DISPUTES)**

The settlement of Disputes or differences that arises between the parties in connection with the implementation of the Contract shall be settled in accordance to Rule XVIII (Settlement of Disputes) of the Revised IRR of RA 9184.

In the event settlement cannot be made, the parties shall abide by the provisions of law with respect to default. The parties hereto agree that the venue for any action shall be the proper courts of the City of Iloilo, exclusively.

The parties shall try to amicably settle all claims and disputes relating to or arising out of this Agreement before resorting to any judicial action.

It is understood that notarial fees for this contract shall be to the account of the CONTRACTOR.

IN WITNESS WHEREOF, the parties to this Agreement have hereunto set their hands this _____ day of _____, 2022 at _____, Philippines.

**UNIVERSITY OF THE PHILIPPINES
VISAYAS**

By:

By:

CLEMENT C. CAMPOSANO
Chancellor

Signed in the presence of:

ACKNOWLEDGMENT

REPUBLIC OF THE PHILIPPINES)
CITY OF _____)S.S.
x ----- x)

The principals:

DR. CLEMENT C. CAMPOSANO, AND _____, appeared in person before

me this _____ day of _____, 2022 in the City of Iloilo, presented to me an integrally complete instrument or document, exhibited to me their Community Tax Certificates, and represented to me that the signatures thereon were voluntarily affixed by them for purposes stated therein, and declared that they executed the same as their free and voluntary act and deed. If acting in a particular capacity, that they have the authority to sign in that capacity.

The parties were identified by competent evidence of identity, showing to me a current identification document issued by:

CLEMENT C. CAMPOSANO, Ph.D. - UP ID # -
TIN -

This instrument or document consists of nine (9) pages, and are signed by the principals and their witnesses on each and every page hereof.

NOTARY PUBLIC

Doc. No. _____;
Page No. _____;
Book. No. _____;
Series of 2022



UNIVERSITY OF THE PHILIPPINES VISAYAS
BIDS AND AWARDS COMMITTEE

Miagao, Iloilo, Philippines 5023
Telephone/Telefax No. (033)3159858 / 3158141 / 3159632 loc 247 / 180
email address: upvbac@yahoo.com

Name of Project:

“RENOVATION OF HEALTH SERVICES UNIT (ITB-2024-008)”

CHECKLIST OF FINANCIAL REQUIREMENTS

The Financial Component shall contain the following:

- Bid Proposals to be typed in the prescribed Bid Form and UPV Bid Tender Form
- Duly signed Bill of Quantities
- Summary of the Detailed Estimates
- Duly signed Detailed Cost Estimates / Bill of Materials
- Duly signed Cash Flow and Payment Schedule

Note:

- 1. Any missing document in the above-mentioned checklist is a ground for outright rejection of the bid**
- 2. Estimates should be consistent with DPWH DO No. 197 Series of 2016 (Revised Guidelines in the Preparation of Approved Budget of The Contract), including related updates.**
- 3. Bid amount must be net of any discount**

Bid Form

Date: _____

ITB No: _____

To: [name and address of Procuring Entity]

Having examined the Philippine Bidding Documents (PBDs) including the Supplemental or Bid Bulletin Numbers [insert numbers], the receipt of which is hereby duly acknowledged, we, the undersigned, declare that:

- a. We have no reservation to the PBDs, including the Supplemental or Bid Bulletins, for the Procurement Project: [insert name of contract];
- b. We offer to execute the Works for this Contract in accordance with the PBDs;
- c. The total bid price includes the cost of all taxes, such as, but not limited to: [specify the applicable taxes, e.g. (i) value added tax (VAT), (ii) income tax, (iii) local taxes, and (iv) other fiscal levies and duties], which are itemized herein and reflected in the detailed estimates,
- d. Our Bid shall be valid within the a period stated in the PBDs, and it shall remain binding upon us at any time before the expiration of that period;
- e. If our Bid is accepted, we commit to obtain a Performance Security in the amount of [insert percentage amount] percent of the Contract Price for the due performance of the Contract, or a Performance Securing Declaration in lieu of the allowable forms of Performance Security, subject to the terms and conditions of issued GPPB guidelines¹² for this purpose;
- f. We are not participating, as Bidders, in more than one Bid in this bidding process, other than alternative offers in accordance with the Bidding Documents; i. We understand that this Bid, together with your written acceptance thereof included in your notification of award, shall constitute a binding contract between us, until a formal Contract is prepared and executed; and
- g. We understand that you are not bound to accept the Lowest Calculated Bid or any other Bid that you may receive.
- h. We likewise certify/confirm that the undersigned, is the duly authorized representative of the bidder, and granted full power and authority to do, execute and perform any and all acts necessary to participate, submit the bid, and to sign and execute the ensuing contract for the [Name of Project] of the [Name of the Procuring Entity].

I/We acknowledge that failure to sign each and every page of this Bid Form, including the Bill of Quantities, shall be a ground for the rejection of our bid.

Name: _____

Legal Capacity: _____

Signature: _____

Duly authorized to sign the Bid for and behalf of: _____

Date: _____



UNIVERSITY OF THE PHILIPPINES VISAYAS
BIDS AND AWARDS COMMITTEE

Miagao, Iloilo, Philippines 5023
Telephone/Telefax No. 315-98-58 / 315-41-41 / 315-96-32 loc 180/247
email address: upvbac@yahoo.com

Name of Project:

“RENOVATION OF HEALTH SERVICES UNIT (ITB-2024-008)”

UPV BID TENDER FORM

Total Bid Amount in Figures: _____

Total Bid Amount in Words: _____

Bidder's Signature

Printed Name

Name of Company

Address

Telephone Number

Name of Project: RENOVATION OF HEALTH SERVICES UNIT (ITB-2024-008)

Location: UPV, Miagao, Iloilo

Approved Budget for Contract: Php 1,994,364.67

Duration: 63 calendar days

DETAILED ESTIMATES

ITEM NO.	DESCRIPTION	QTY.	UNIT	ESTIMATED DIRECT COST	MARK-UPS IN PERCENT		TOTAL MARK-UP		VAT	TOTAL INDIRECT COST	TOTAL COST	UNIT COST
					OCM	PROFIT	%	VALUE				
(1)	(2)	(3)	(4)	(5)	(6)	(7)	(8)	(9)	(10)	(11)	(12)	(13)
							(6)+(7)	(5)x(8)	5%[(5)+(9)]	(9)+(10)	(5)+(11)	(12)/(3)
1	General Requirements											
1.a.	Temporary Facilities	1	lot	-				-	-	-	-	-
1.b.	Safety and Health	1	lot	-				-	-	-	-	-
1.c.	Electricity and Water Consumption	1	lot	-				-	-	-	-	-
1.d.	Mobilization and Demobilization	1	lot	-				-	-	-	-	-
2	Site Preparation	1	lot	-	5%	10%	15%	-	-	-	-	-
3	Renovation of Laboratories											
3.a.	Transfer of Tables, Equipments, Etc.	1	lot	-	5%	10%	15%	-	-	-	-	-
3.b.	Demolition of Existing Walls, Chipping, Hauling of Debris	1	lot	-	5%	10%	15%	-	-	-	-	-
3.c.	Covering of Existing Doors and Window Openings	1	lot	-	5%	10%	15%	-	-	-	-	-
3.d.	Installation of Partitions and Concave Floor to Wall Connection	1	lot	-	5%	10%	15%	-	-	-	-	-
3.e.	Installation of Counters with Sink	1	lot	-	5%	10%	15%	-	-	-	-	-
3.f.	Installation of Doors	1	lot	-	5%	10%	15%	-	-	-	-	-
3.g.	Ceiling Works	1	lot	-	5%	10%	15%	-	-	-	-	-
3.h.	Painting Works	1	lot	-	5%	10%	15%	-	-	-	-	-
3.i.	Electrical Works	1	lot	-	5%	10%	15%	-	-	-	-	-
3.j.	Plumbing Works including STP	1	lot	-	5%	10%	15%	-	-	-	-	-
3.k.	Tiling Works	1	lot	-	5%	10%	15%	-	-	-	-	-
4	Extension of Hallway											
4.a.	Excavation	1	lot	-	5%	10%	15%	-	-	-	-	-
4.b.	Rebar, Concrete and Form Works (Including Parapet Wall, Railings and Waste Holding Area)	1	lot	-	5%	10%	15%	-	-	-	-	-
4.c.	Painting Works	1	lot	-	5%	10%	15%	-	-	-	-	-
TOTAL (PHP)				-				-	-	-	-	-

PHP

-

Name of Project: RENOVATION OF HEALTH SERVICES UNIT (ITB-2024-008)
 Location: UPV, Miagao, Iloilo
 Approved Budget for Contract: Php 1,994,364.67
 Duration: 63 calendar days

DETAILED COST ESTIMATES / BILL OF MATERIALS

QTY.	UNIT	DESCRIPTION	UNIT COST	TOTAL COST
1	General Requirements			
1.a.	Temporary Facilities			
	lot	Temporary Facilities,Fence Enclosure/Bunkhouse & Office		0.00
1.b.	Safety and Health			
	lot	PPE's, Alcohol, facemask, thermal scanner, etc...		-
1.c.	Electricity and Water Consumption			
	lot	Provision and Consumption of Electricity/Water		0.00
1.d.	Mobilization and Demobilization			
	lot	Mobilization/Demobilization		-
		Sub-Total 1	Php	-
2	Site Preparation			
		Man Power	# of Persons	# of Days
		Foreman		Wage/Day
		Laborer/Helper		-
			Labor Cost	-
		Sub-Total 2	Php	-
3	Renovation of Laboratories			
3.a.	Transfer of Tables, Equipments, Etc.			
		Man Power	# of Persons	# of Days
		Laborer/Helper		Wage/Day
			Labor Cost	-
		Sub-Total	Php	-
3.b.	Demolition of Existing Walls, Chipping, Hauling of Debris			
		Equipment:	Unit/s	no. of Days
		Jackhammer		Rate/day
			Equipment Cost	Amount
				-
		Man Power	# of Persons	# of Days
		Laborer/Helper		Wage/Day
			Labor Cost	-
		Sub-Total	Php	-
3.c.	Covering of Existing Doors and Window Openings			
	sets	Expanded Polystyrene Panel (2"x4'x10') with wire mesh		-
	set	Flat Mesh, 8'		-
	bags	Cement		-
	cu.m.	Sand		-
	lgth	10mm x 6.0m RSB Def.		-
	kls	#16 Tie Wire		-
			Cost of Materials	-
		Man Power	# of Persons	# of Days
		Mason/Steelman		Wage/Day
		Laborer/Helper		-
			Labor Cost	-

		Labor Cost		
		Sub-Total	Php	-
3.d.	Installation of Partitions and Concave Floor to Wall Connection			
	set Expanded Polystyrene Panel (2"x4'x10') with wire mesh			-
	set Flat Mesh, 8'			-
	set Angle Mesh, 8'			-
	set U Mesh, 8'			-
	bags Cement			-
	cu.m. Sand			-
	lgth 10mm x 6.0m RSB Def.			-
	cls #16 Tie Wire			-
		Cost of Materials		-
			Wage/Day	
	Man Power	# of Persons	# of Days	
	Foreman			-
	Mason/Steelman			-
	Laborer/Helper			-
		Labor Cost		-
		Sub-Total	Php	-
3.e.	Installation of Counters with Sink Including Slop Sink & Janitors Cabinet			
	sets 20" x 16" x 8" Stainless Steel Drop-In Sink, Single Compartment, with stainless steel gooseneck faucet including accessories			-
	lgth 2" x 2" x 10" S4S Lumber			-
	shts 3/4" x 4' x 8' Marine Plywood, Good Quality			-
	shts 4' x 8' Formica, White			-
	cls Assorted CWN Nails			-
	cls Assorted Finishing Nails			-
	gal Flat wall enamel primer			-
	gal Semi Gloss enamel			-
	pcs 2" Paint Brush			-
	pcs Baby Roller			-
	gal Masonry Putty			-
	bottle Rugby			-
	shts #120 Sandpaper			-
		Cost of Materials		-
			Wage/Day	
	Man Power	# of Persons	# of Days	
	Carpenter			-
	Laborer/Helper			-
		Labor Cost		-
		Sub-Total	Php	-
3.f.	Installation of Doors			
	units D1, 1.0m x 2.10m Hollow Core Flush Door on Wood Frame, w/ Vision Glass, self-closing with accessories			-
	units D2, 0.90m x 2.10m Hollow Core Flush Door on Wood Frame, w/ Vision Glass and accessories			-
	units D3, 0.80m x 2.10m Hollow Core Flush Door on Wood Frame, w/ Vision Glass and accessories			-
	unit D4, 1.00m x 2.10m Aluminum Flush Door Complete with Accessories			-
		Cost of Materials		-
			Wage/Day	
	Man Power	# of Persons	# of Days	
	Carpenter			-

pcs.	Solderless Connector, two bolt type, burndy for 200 sq. mm wire	-
length	5/8" x 10 ft. ground rod, copper	-
pcs.	5/8" Ground rod connector, cu. two bolt type, burndy	-
kls	#16 G.I pull wire	-
lot	Clearing of existing electrical lines affected	-
set	Molded Case Circuit Breaker, Cu bus bar, bolt-on type, 3Phase	-
	Main: 1 set - 125 Amp., 2P, 240V, 25 KAIC, Bolt-on, Industrial type	
	Branches: 2 sets - 15 Amp., 2P, Bolt-on, 240V	
	9 sets - 20 Amp., 2P, Bolt-on, 240V	
	3 sets - 30 Amp., 2P, Bolt-on, 240V	

		Cost of Materials		-
		# of Days	Wage/Day	
	Man Power	# of Persons		
	Electrician			-
	Laborer/Helper			-
		Labor Cost		-
		Sub-Total	Php	-

3.j. Plumbing Works including STP

lengths	100mmø x 3.0m PVC Pipe, S-1000	-
lengths	75mmø x 3.0m PVC Pipe, S-1000	-
pcs	100mmø x 100mmø PVC Wye	-
pcs	75mmø x 75mmø PVC Wye	-
pcs	100mmø x 90° PVC Elbow	-
pcs	75mmø x 90° PVC Elbow	-
pcs	100mmø x 45° PVC Elbow	-
pcs	75mmø x 45° PVC Elbow	-
pcs	75mmø PVC P-Trap	-
pcs	100mmø x 100mmø PVC Floor Drain	-
pcs	100mmø PVC Clean Out	-
pcs	75mmø PVC Clean Out	-
cans	400cc PVC Solvent Cement	-
lengths	25mmø x 4.0m PPR Pipes	-
pcs	25mmø PPR Coupling	-
pcs	25mmø PPR Tee Equal	-
pcs	25mmø x 90° PPR Elbow Equal	-
pcs	25mmø x 90° PPR Elbow w/ thread	-
sets	Shower Head, American Standard w/ Complete Accessories	-
sets	Water Closet, American Standard w/ Complete Accessories	-
sets	Wall-Hung Lavatory, w/ Complete Accessories	-
sets	Urinal, American Standard w/ Complete Accessories	-
pcs	Tissue Holder	-
sq ft	Mirror (6mm thk.)	-
bags	Cement	-
cu.m.	Sand	-
cu.m.	Gravel	-
lgth	10mm x 6.0m RSB Def.	-
kls	#16 Tie Wire	-

		Cost of Materials		-
		# of Days	Wage/Day	
	Man Power	# of Persons		
	Mason			-
	Plumber			-
	Laborer/Helper			-
		Labor Cost		-
		Sub-Total	Php	-

3.k. Tiling Works
Floor Preparation (Removal of Existing Tiles)

		Man Power	# of Persons	# of Days	Wage/Day	
		Laborer/Helper				-
				Labor Cost		-
Tiling of Laboratories and Comfort Room						
pcs	60cm x 60cm Non-Skid Floor Tiles					-
pcs	60cm x 60cm Porcelain Wall Tiles					-
bags	Portland Cement, 40kgs					-
cu m	Screened Sand					-
kgs	Joint Filler					-
bags	Tile Adhesive, 25kgs					-
pcs	0.60m x 0.60m Granite Tiles					-
					Material Cost	0.00
		Man Power	# of Persons	# of Days	Wage/Day	Amount
		Tile Setter				-
		Laborer/Helper				-
				Sub-Total	Labor Cost	-
					Php	-
				Sub-Total 3	Php	-
4	Extension of Hallway					
4.a.	Excavation					
		Man Power	# of Persons	# of Days	Wage/Day	
		Laborer/Helper				-
				Labor Cost		-
				Sub-Total	Php	-
4.b.	Rebar, Concrete and Form Works (Including Parapet Wall, Railings and Waste Holding Area)					
pcs	4" CHB					-
bags	Cement					-
cu.m.	Sand					-
cu.m.	Gravel					-
lgth	16mm x 6.0m RSB Def.					-
lgth	12mm x 6.0m RSB Def.					-
lgth	10mm x 6.0m RSB Def.					-
lgth	2" GI Pipe					-
lgth	1 1/2"x1 1/2"x1/4" Angle Bar					-
kilos	Welding Rod					-
lgth	Coco Lumber, 2x2x8					-
shts	1/2" x 4' x 8' Ordinary Plywood					-
kls	CWN 4"					-
kls	CWN 2 1/2"					-
kls	#16 Tie Wire					-
					Cost of Materials	-
		Man Power	# of Persons	# of Days	Wage/Day	
		Foreman				-
		Mason/Steelman				-
		Laborer/Helper				-
				Labor Cost		-
				Sub-Total	Php	-
4.c.	Painting Works					
gal	Flatwall Latex Paint					-
gal	Semi-Gloss Latex Paint					-
gal	Concrete Neutralizer					-

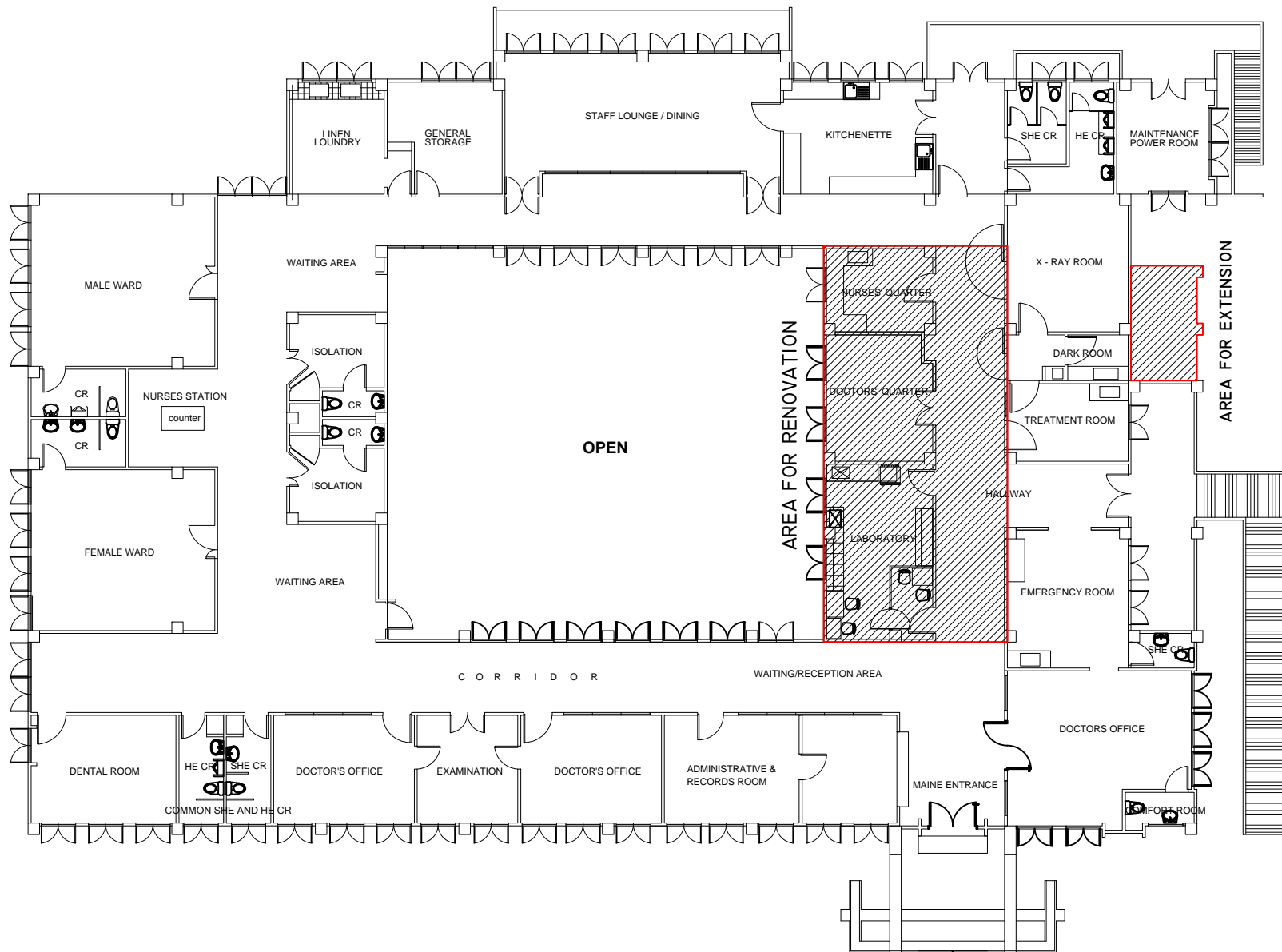

HEALTH SERVICES UNIT BLG. EXISTING FLOOR PLAN

PREPARED BY:	CERTIFIED CORRECT:	PROJECT TITLE:	RECOMMENDED:	RECOMMENDING APPROVAL:	APPROVED:	SHEET CONTENT:
RUSSELL JAY GARMAY	MEG BRYAN G. GICANA	PROPOSED RENOVATION OF HEALTH SERVICES UNIT	MARIO M. MORANO	MA. CECILIA VILLARUZ	FARISAL U. BAGSIT	01
ARCHITECTURAL AIDE, CDMO	ENGINEER, CDMO	LOCATION: UPV ILOILO CITY CAMPUS	CHIEF, CDMO	CHIEF, HSU	VICE CHANCELLOR FOR ADMINISTRATION	-AS SHOWN
					CLEMENT C. CAMPOSANO	08
					UPV CHANCELLOR	

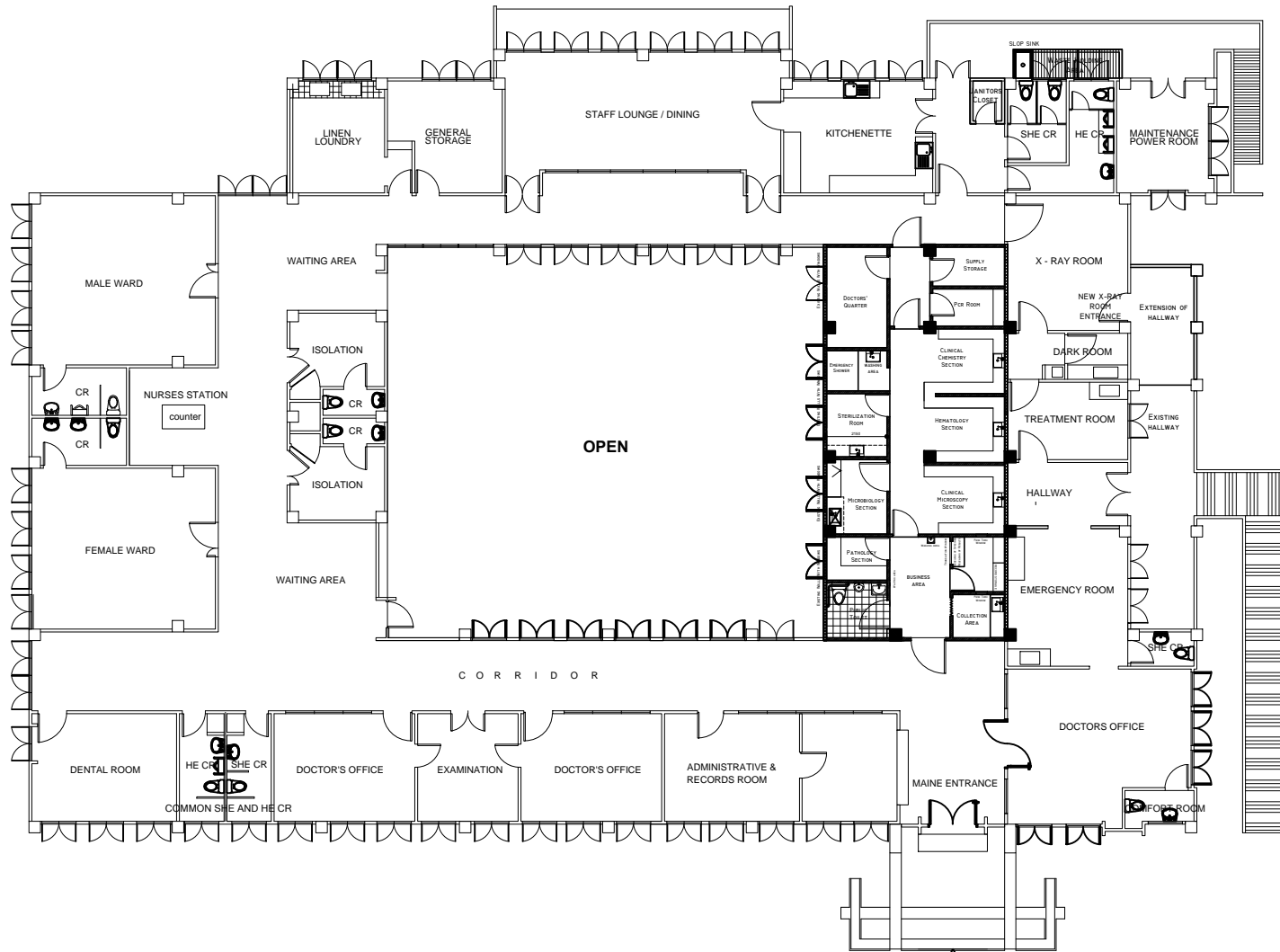

HEALTH SERVICES UNIT BLG. PROPOSED FLOOR PLAN

PREPARED BY:	CERTIFIED CORRECT:	PROJECT TITLE:	RECOMMENDED:	RECOMMENDING APPROVAL:	APPROVED:	SHEET CONTENT:
RUSSELL JAY GARMAY	MEG BRYAN G. GICANA	PROPOSED RENOVATION OF HEALTH SERVICES UNIT	MARIO M. MORANO	MA. CECILIA VILLARUZ	FARISAL U. BAGSIT	CLEMENT C. CAMPOSANO
ARCHITECTURAL AIDE, CDMO	ENGINEER, CDMO	LOCATION: UPV ILOILO CITY CAMPUS	CHIEF, CDMO	CHIEF, HSU	VICE CHANCELLOR FOR ADMINISTRATION	UPV CHANCELLOR

02	08
----	----

-AS SHOWN

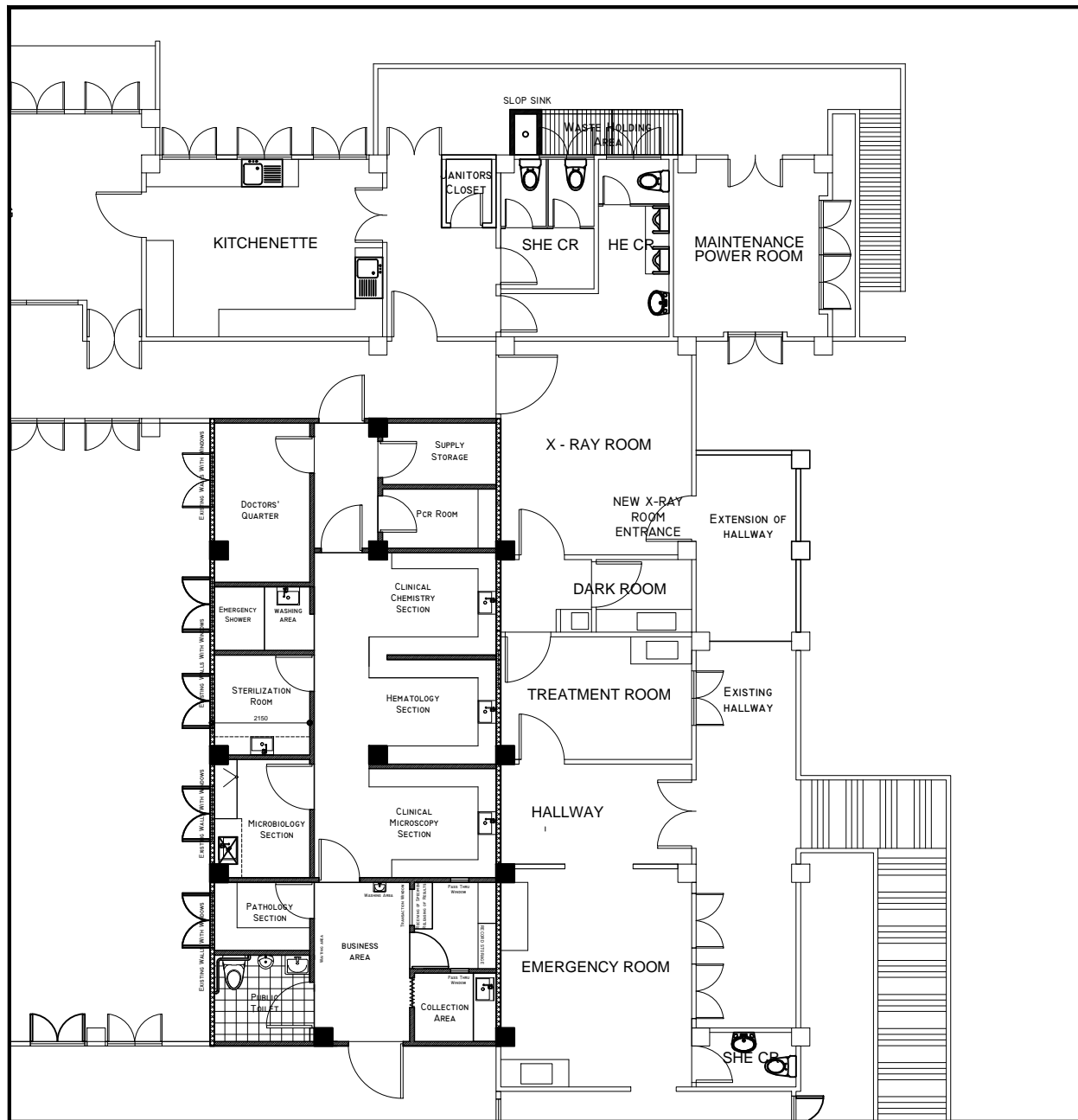

EXISTING STRUCTURE



PROPOSED EXTENSION

PREPARED BY: RUSSELL JAY GARMAY ARCHITECTURAL AIDE, CDMO	CERTIFIED CORRECT: MEG BRYAN G. GICANA ENGINEER, CDMO	PROJECT TITLE: PROPOSED RENOVATION OF HEALTH SERVICES UNIT LOCATION: UPV ILOILO CITY CAMPUS	RECOMMENDED: MARIO M. MORANO CHIEF, CDMO	RECOMMENDING APPROVAL: MA. CECILA VILLARUZ CHIEF, HSU	APPROVED: FARISAL U. BAGSIT VICE CHANCELLOR FOR ADMINISTRATION	APPROVED: CLEMENT C. CAMPOSANO UPV CHANCELLOR	SHEET CONTENT: -AS SHOWN	03 08
---	--	--	---	--	---	--	-----------------------------	------------------------

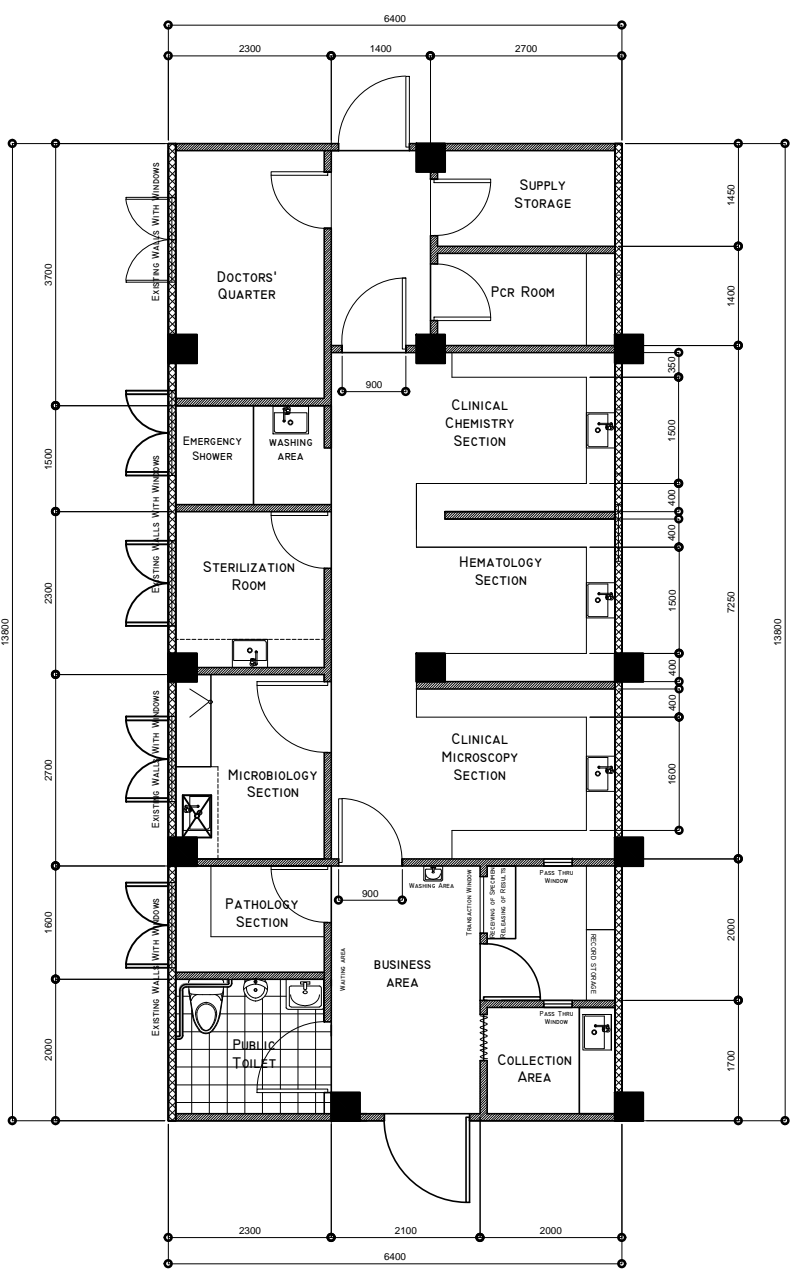

PROPOSED FLOOR PLAN

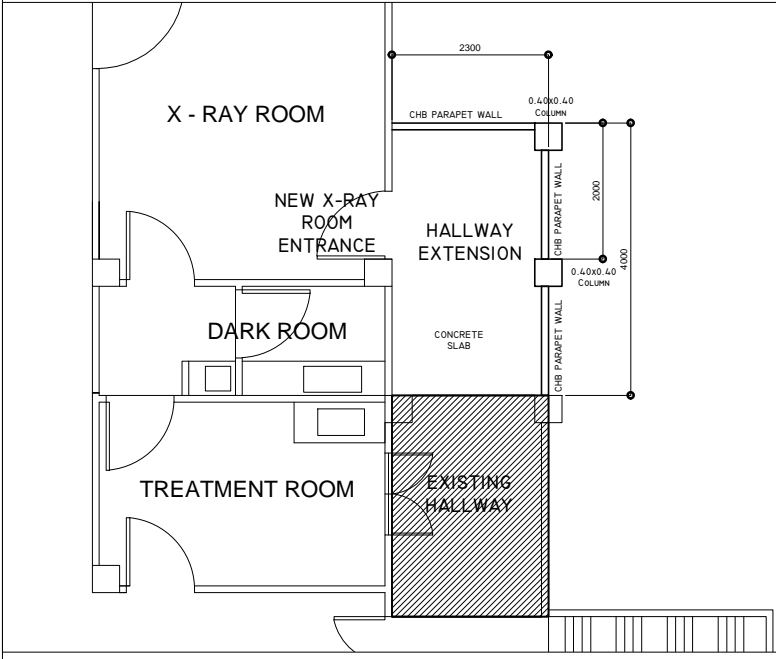

EXTENSION OF HALLWAY

	EXISTING CONCRETE WALLS
	3D WALL PANEL

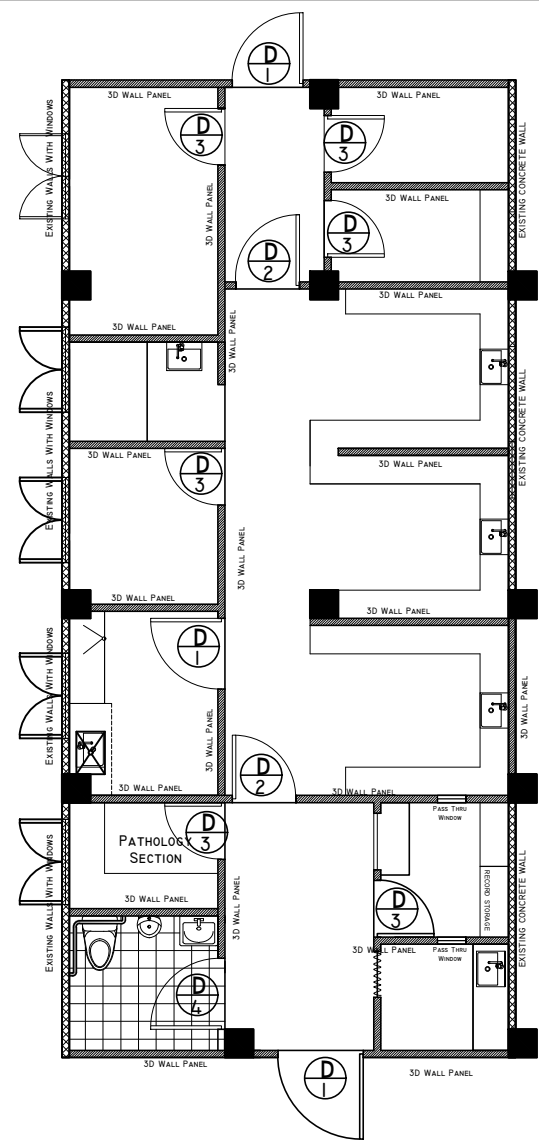

PREPARED BY: RUSSELL JAY GARMAY ARCHITECTURAL AIDE, CDMO	CERTIFIED CORRECT: MEG BRYAN G. GICANA ENGINEER, CDMO	PROJECT TITLE: PROPOSED RENOVATION OF HEALTH SERVICES UNIT LOCATION: UPV ILOILO CITY CAMPUS	RECOMMENDED: MARIO M. MORANO CHIEF, CDMO	RECOMMENDING APPROVAL: MA. CECILIA VILLARUZ CHIEF, HSU	APPROVED: FARISAL U. BAGSIT VICE CHANCELLOR FOR ADMINISTRATION	APPROVED: CLEMENT C. CAMPOSANO UPV CHANCELLOR	SHEET CONTENT: -AS SHOWN	04 08
---	--	--	---	---	---	--	-----------------------------	------------------------

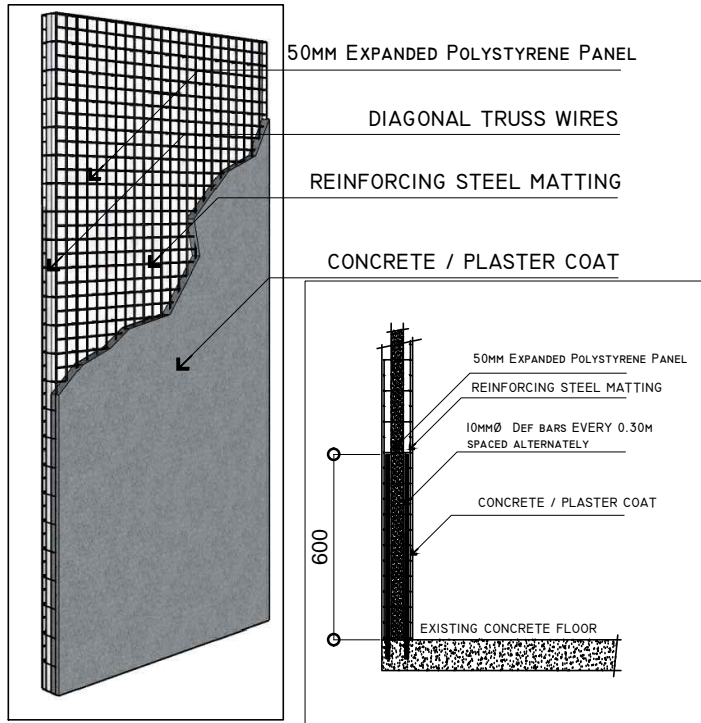

3D WALL PANEL DETAILS

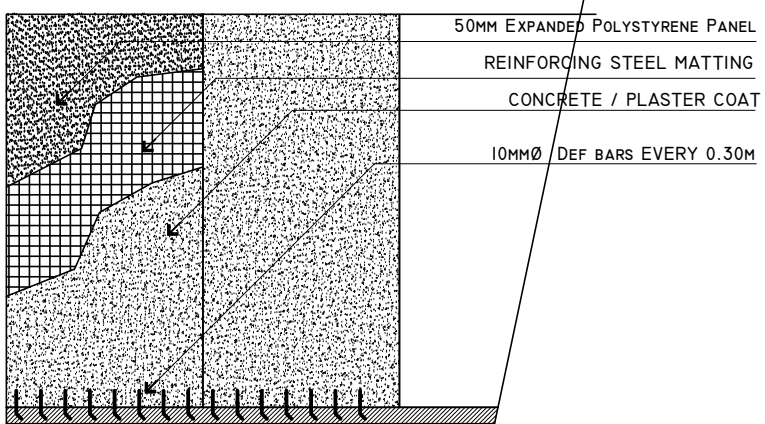

3D WALL PANEL

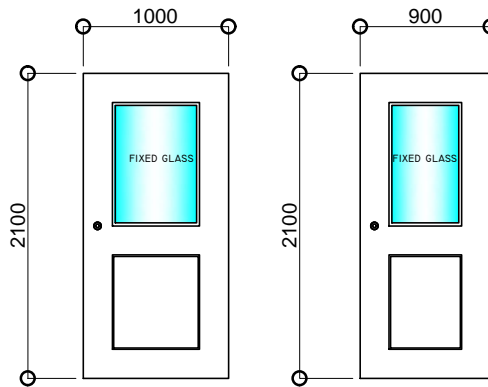

DOOR 1

DOOR 2

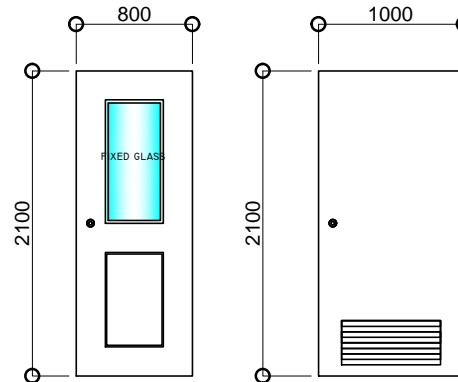

DOOR 3

DOOR 4

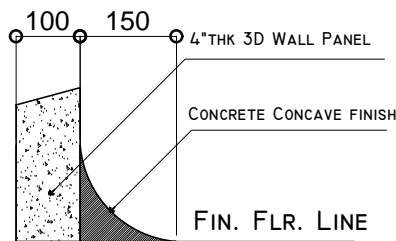

CONCRETE CONCAVE FINISH IN ALL FLOOR TO WALL CONNECTIONS

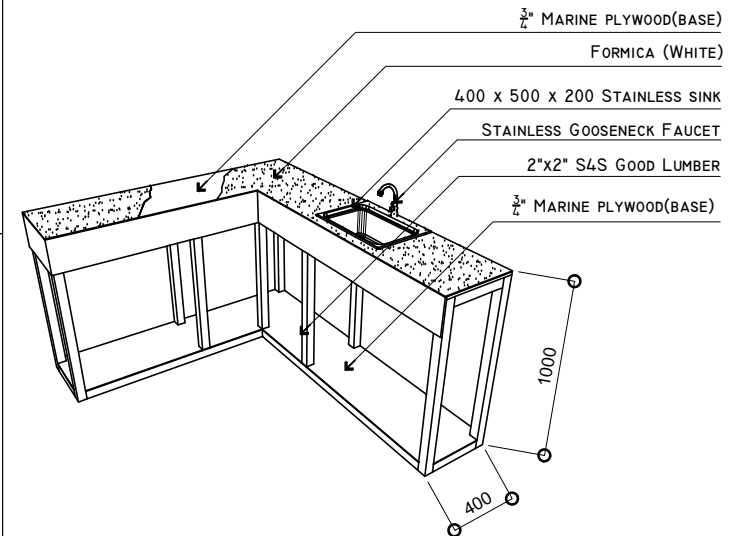
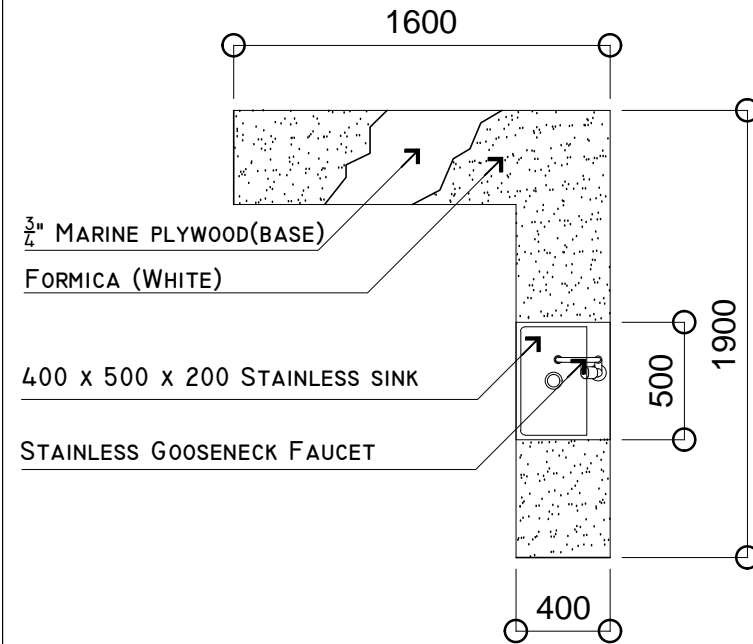

TYPICAL COUNTER WITH SINK DETAILS

PREPARED BY: RUSSELL JAY GARMAY ARCHITECTURAL AIDE, CDMO	CERTIFIED CORRECT: MEG BRYAN G. GICANA ENGINEER, CDMO	PROJECT TITLE: PROPOSED RENOVATION OF HEALTH SERVICES UNIT LOCATION: UPV ILOILO CITY CAMPUS	RECOMMENDED: MARIO M. MORANO CHIEF, CDMO	RECOMMENDING APPROVAL: MA. CECILA VILLARUZ CHIEF, HSU	APPROVED: FARISAL U. BAGSIT VICE CHANCELLOR FOR ADMINISTRATION	APPROVED: CLEMENS C. CAMPOSANO UPV CHANCELLOR	SHEET CONTENT: -AS SHOWN	05 08
--	---	---	--	---	--	---	-----------------------------	----------

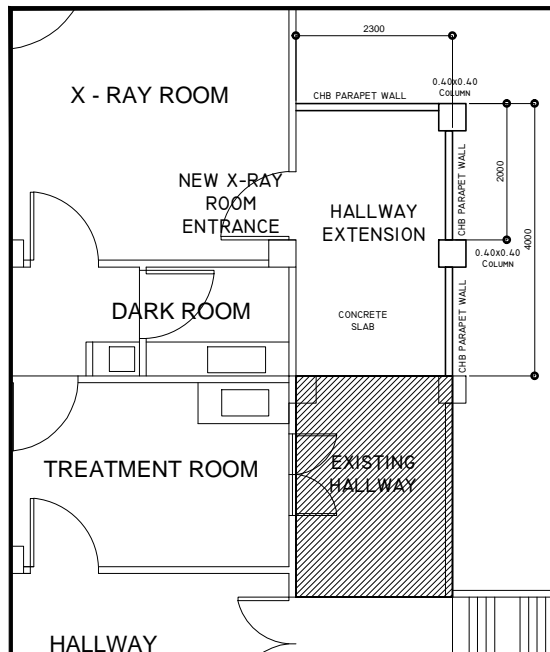

EXTENSION OF HALLWAY

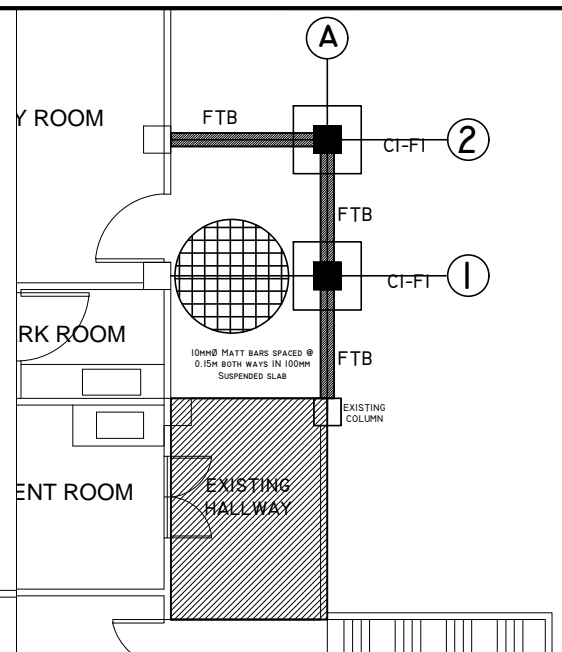

FOUNDATION LAY-OUT

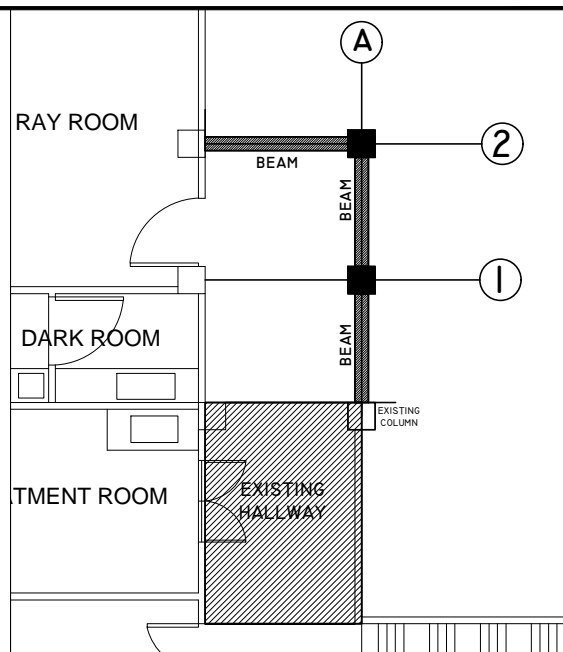

BEAM LAY-OUT

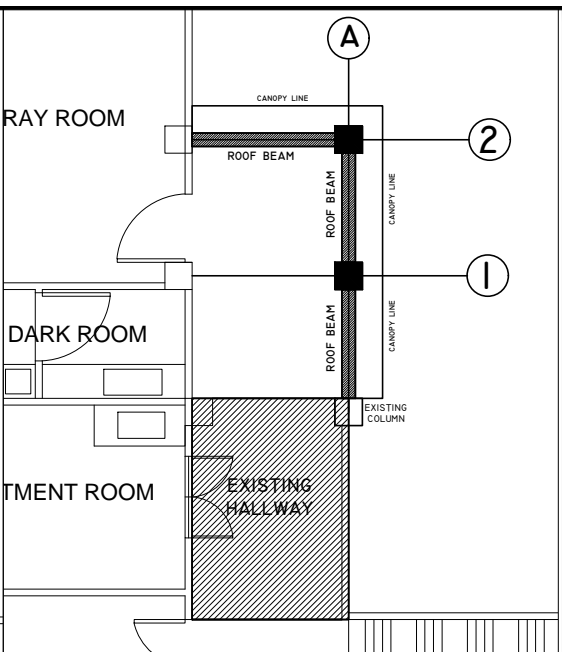

ROOF BEAM LAY-OUT

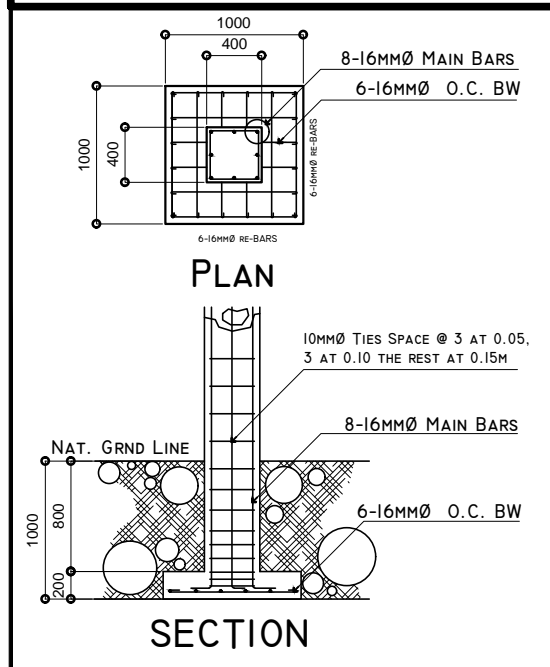

SECTION

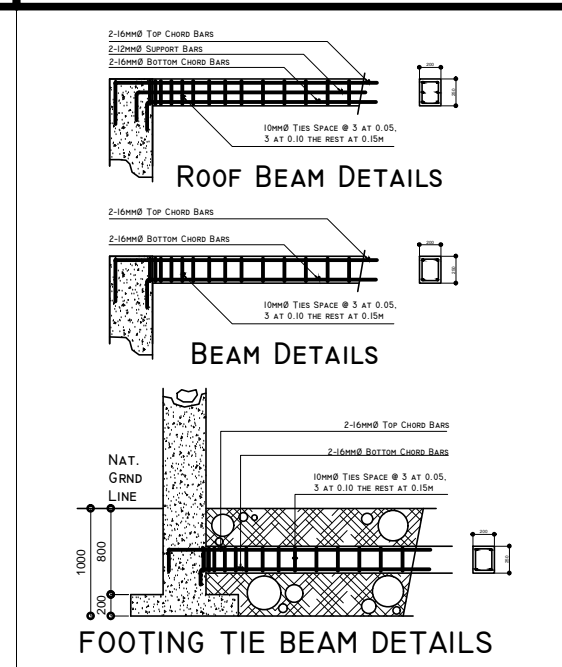

FOOTING TIE BEAM DETAILS

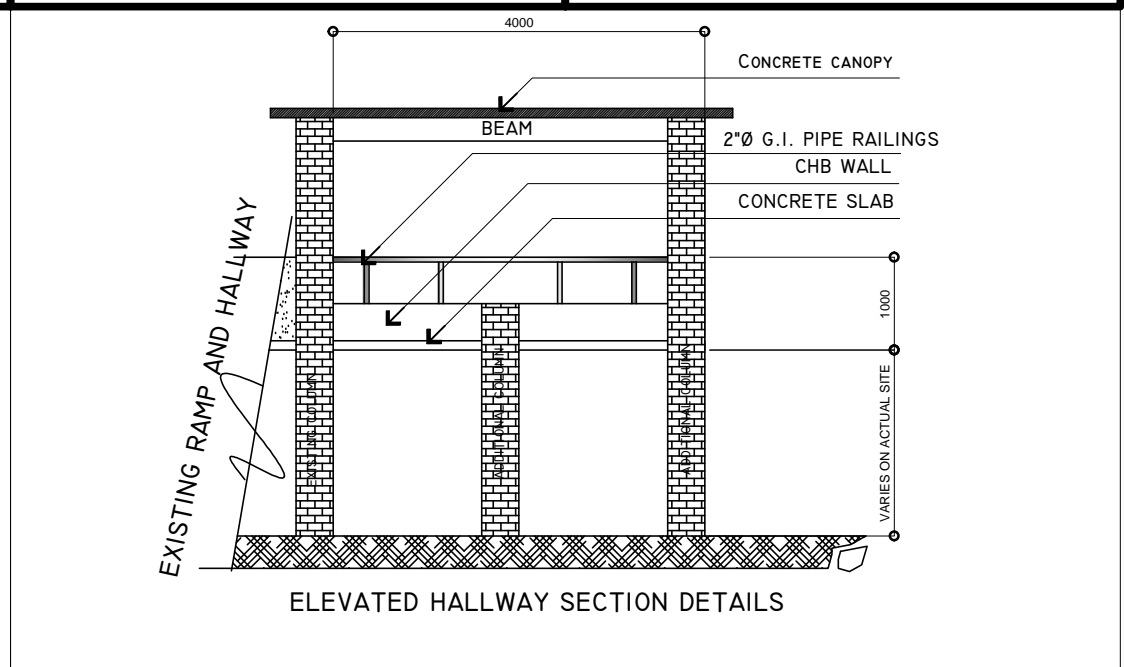

ELEVATED HALLWAY SECTION DETAILS

PREPARED BY: RUSSELL JAY GARMAY ARCHITECTURAL AIDE, CDMO	CERTIFIED CORRECT: MEG BRYAN G. GICANA ENGINEER, CDMO	PROJECT TITLE: PROPOSED RENOVATION OF HEALTH SERVICES UNIT LOCATION: UPV ILOILO CITY CAMPUS	RECOMMENDED: MARIO M. MORANO CHIEF, CDMO	RECOMMENDING APPROVAL: MA. CECILIA VILLARUZ CHIEF, HSU	APPROVED: FARISAL U. BAGSIT VICE CHANCELLOR FOR ADMINISTRATION	APPROVED: CLEMENS C. CAMPOSANO UPV CHANCELLOR	SHEET CONTENT: -AS SHOWN	06 08
--	---	---	--	--	--	---	-----------------------------	----------

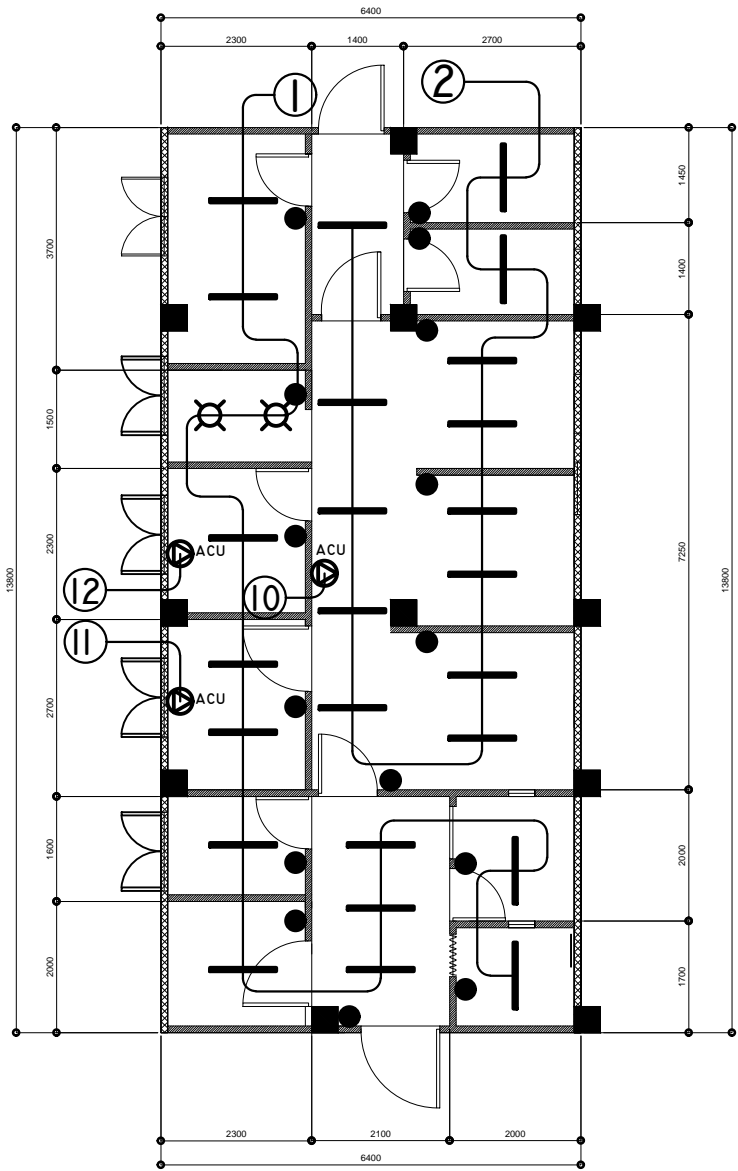

LIGHTING LAY-OUT

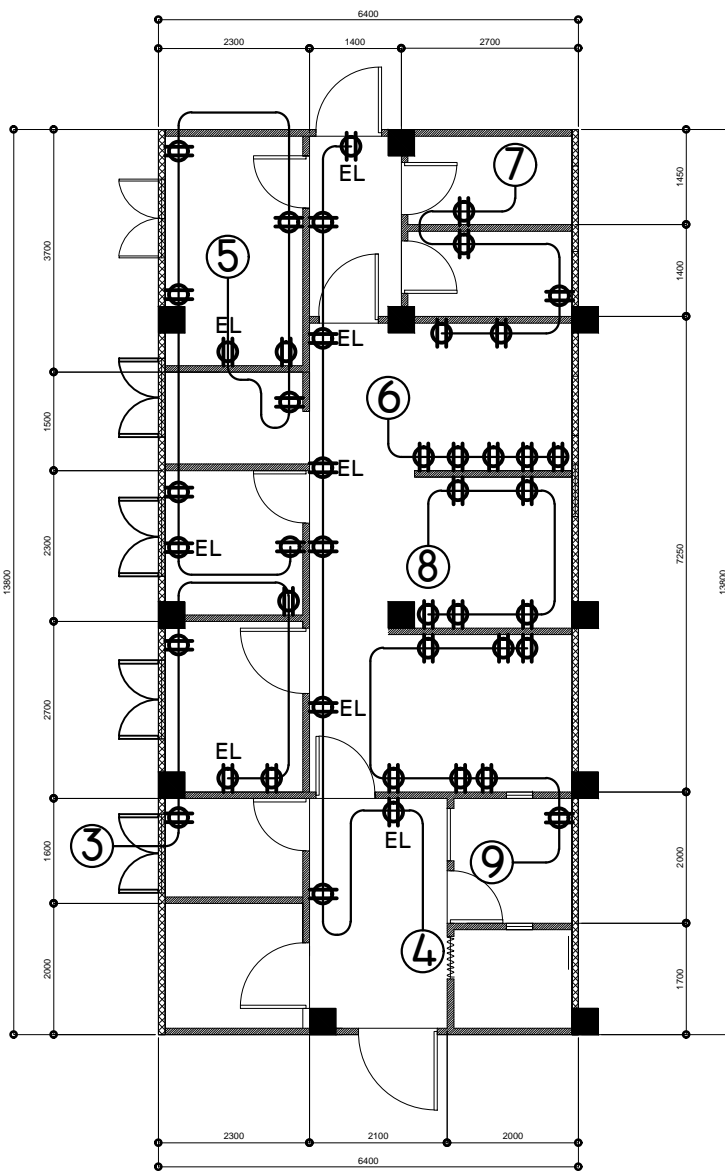

POWER LAY-OUT

SCHEDULE OF LOADS

CKT NO.	LOAD DESCRIPTION	LOAD			OUTLETS			SIZE OF CONDUCTOR	CKT PROTECTION		SIZE OF CONDUITS mm dia. (øPVC)	
		V	VA	I	LO	CO	OTHERS		AT	F		KAC
1	Lightings	230	225	0.978	1,22283	14		2-3.5 mm. sq. THHN Cu. Wire	15	2	10	20
2	Lightings	230	171	0.743	0,92935	13		2-3.5 mm. sq. THHN Cu. Wire	15	2	10	20
3	C.O	230	900	3.913	4.8913	2		2-3.5 mm. sq. THHN Cu. Wire + 1C 3.5 mm sq. THHN Cu. Wire-GND	20	2	10	20
4	C.O	230	1260	5.478	6.84783	7		2-3.5 mm. sq. THHN Cu. Wire + 1C 3.5 mm sq. THHN Cu. Wire-GND	20	2	10	20
5	C.O	230	1620	7.043	8.80455	9		2-3.5 mm. sq. THHN Cu. Wire + 1C 3.5 mm sq. THHN Cu. Wire-GND	20	2	10	20
6	C.O	230	900	3.913	4.8913	5		2-3.5 mm. sq. THHN Cu. Wire + 1C 3.5 mm sq. THHN Cu. Wire-GND	20	2	10	20
7	C.O	230	900	3.913	4.8913	5		2-3.5 mm. sq. THHN Cu. Wire + 1C 3.5 mm sq. THHN Cu. Wire-GND	20	2	10	20
8	C.O	230	900	3.913	4.8913	5		2-3.5 mm. sq. THHN Cu. Wire + 1C 3.5 mm sq. THHN Cu. Wire-GND	20	2	10	20
9	C.O	230	1440	6.261	7.82609	8		2-3.5 mm. sq. THHN Cu. Wire + 1C 3.5 mm sq. THHN Cu. Wire-GND	20	2	10	20
10	ACU	230	2238	9.73	14.5957			2-5.5 mm. sq. THHN Cu. Wire + 1C 3.5 mm sq. THHN Cu. Wire-GND	30	2	10	20
11	ACU	230	1865	8.109	12.163			2-5.5 mm. sq. THHN Cu. Wire + 1C 3.5 mm sq. THHN Cu. Wire-GND	30	2	10	20
12	ACU	230	1865	8.109	12.163			2-5.5 mm. sq. THHN Cu. Wire + 1C 3.5 mm sq. THHN Cu. Wire-GND	30	2	10	20
13	SPARE	230	2300	10					20	2	10	
14	SPARE	230	2000	8.696					20	2	10	
	TOTAL	230	11330	50.8					125	2	25	40

TOTAL I = 80.5 x 1.25 = 101 Amperes

Main Feeder:
2C-38 sq.mm. THW Cu. Wire + 1C-8.0 sq.mm. THW Cu. Wire- GND
125AT, 3POLE, 25KAC @ 240V, Square D, bolt-on
40 mm øPVC Electrical Conduit, thickwall, Atlanta

2c-30sq M THW CU. WIRE
@40MM øPVC ELECT'L PIPE

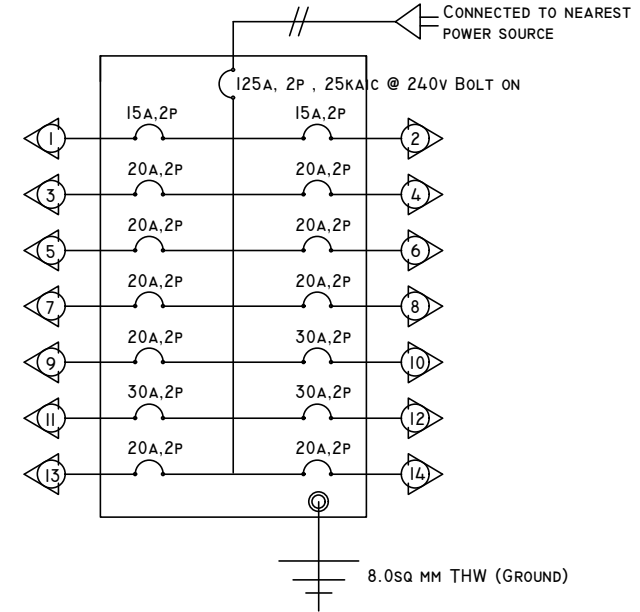

SINGLE LINE DIAGRAM

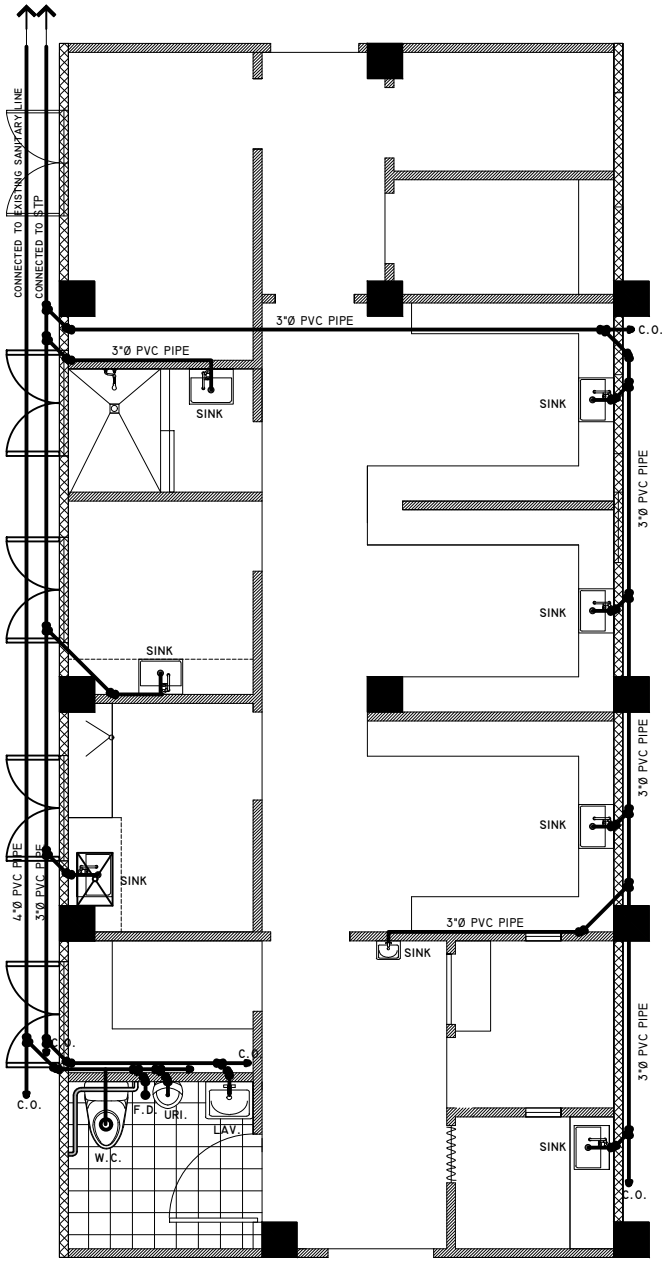

SANITARY LINE LAY-OUT

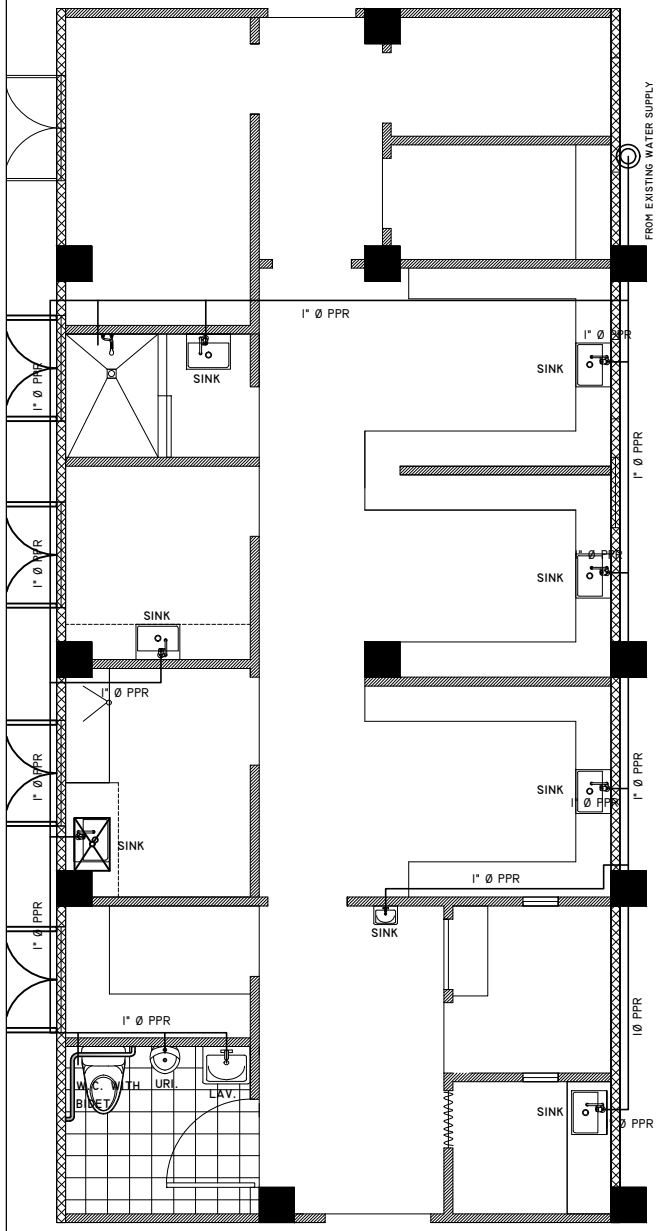

WATER LINE LAY-OUT

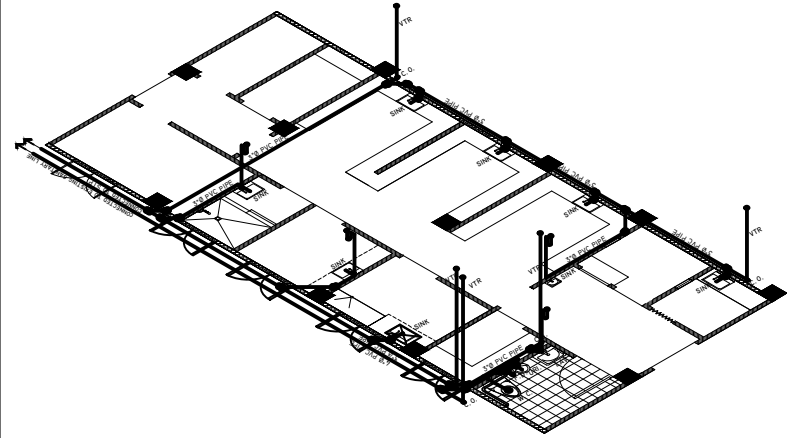

SANITARY LINE ISOMETRIC LAY-OUT

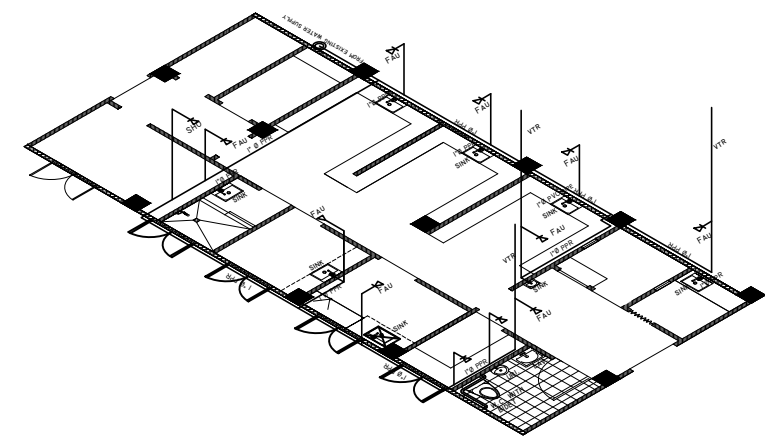

WATER LINE ISOMETRIC LAY-OUT

PREPARED BY: RUSSELL JAY GARMAY ARCHITECTURAL AIDE, CDMO	CERTIFIED CORRECT: MEG BRYAN G. GICANA ENGINEER, CDMO	PROJECT TITLE: PROPOSED RENOVATION OF HEALTH SERVICES UNIT LOCATION: UPV ILOILO CITY CAMPUS	RECOMMENDED: MARIO M. MORANO CHIEF, CDMO	RECOMMENDING APPROVAL: MA. CECILA VILLARUZ CHIEF, HSU	APPROVED: FARISAL U. BAGSIT VICE CHANCELLOR FOR ADMINISTRATION	APPROVED: CLEMENT C. CAMPOSANO UPV CHANCELLOR	SHEET CONTENT: -AS SHOWN	08 08
---	--	--	---	--	---	--	-----------------------------	----------

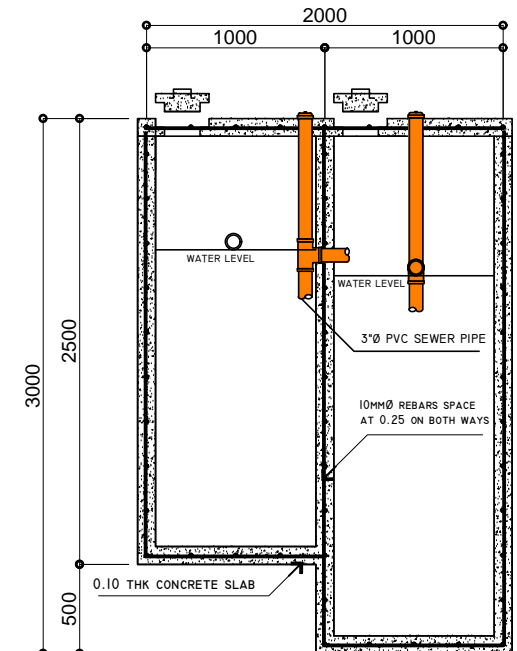
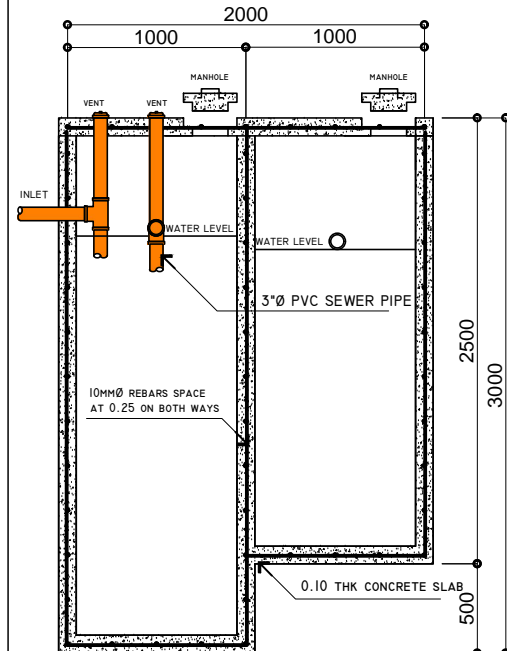
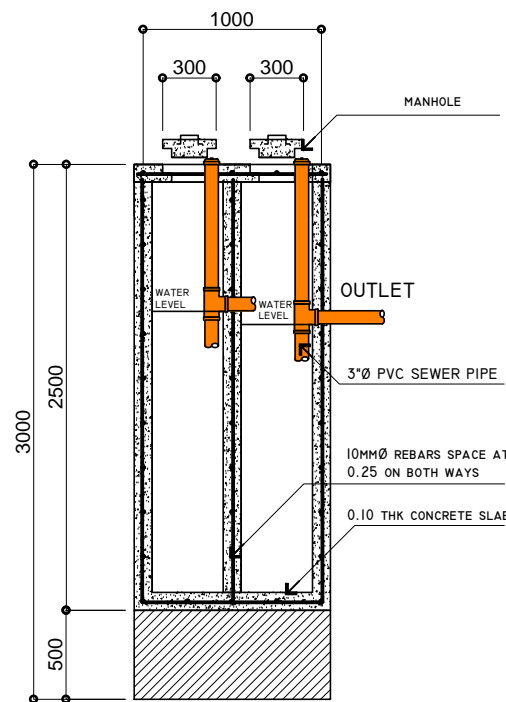
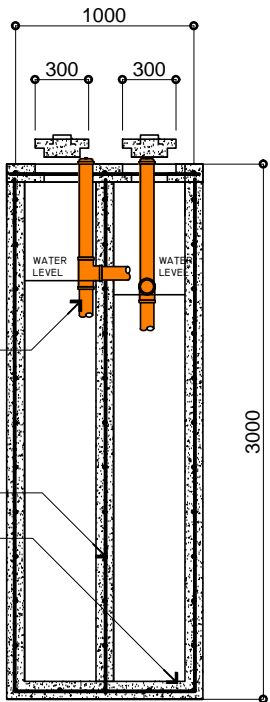
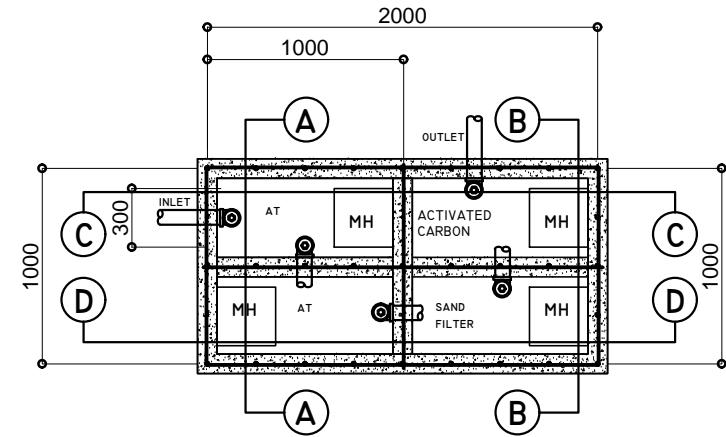
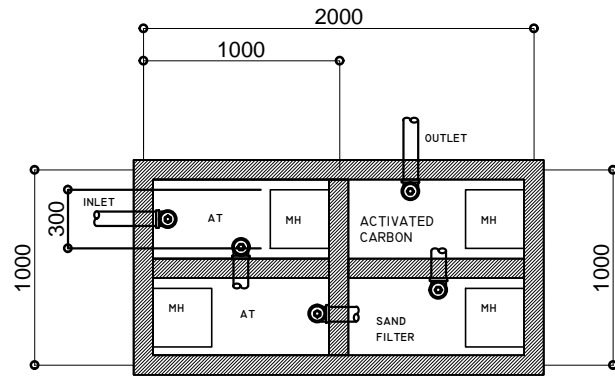

PREPARED BY: RUSSELL JAY GARMAY ARCHITECTURAL AIDE, CDMO	CERTIFIED CORRECT: CHELSEA PUNZALAN-MENDOZA PCO, SANITARY ENGINEER	PROJECT TITLE: PROPOSED RENOVATION OF HEALTH SERVICES UNIT LOCATION: UPV ILOILO CITY CAMPUS	RECOMMENDED: MARIO M. MORANO CHIEF, CDMO	RECOMMENDING APPROVAL: MA. CECILIA VILLARUZ CHIEF, HSU	APPROVED: FARISAL U. BAGSIT VICE CHANCELLOR FOR ADMINISTRATION	APPROVED: CLEMENS C. CAMPOSANO UPV CHANCELLOR	SHEET CONTENT: -AS SHOWN
--	--	---	--	--	--	---	-----------------------------